

Selection tool

Nylon and polypropylene wheels and castors



Series	PPN	PP	POW
Tread / wheel centre	Polypropylene		Nylon with elastic solid rubber pads
Tread and tyre hardness	60 Shore D	60 Shore D	70 Shore D
Non-marking	✓	✓	✓
Electrical conductivity	optional (PP series)	optional	–
Wheel Ø	60–200 mm	60–200 mm	100–125 mm
Load capacity up to	450 kg	450 kg	220 kg
Low-noise operation	–	–	✓
Use on suitable concrete floors	✓	✓	✓
Chemical resistance	■■■■■	■■■■■	■■■□□
Use in wet areas	■■■■■	■■■■■	■■■□□
For a description of the wheel, refer to	page 332	page 336	page 340
For information about swivel and fixed castors, refer to	page 333–335	page 337–339	page 341–342

■■■■■ excellent

■■■■ very good

■■■ good

■■ satisfactory

■ sufficient

✓ yes – no



PO	SPO	GSPO
Nylon		Cast nylon
70 Shore D	70 Shore D	80 Shore D
✓	✓	✓
optional	–	–
50–300 mm	75–250 mm	35–1,000 mm
1,500 kg	2,000 kg	50,000 kg
–	–	–
✓	under certain circumstances	–
■ ■ ■ ■ ■ □	■ ■ ■ ■ ■ □	■ ■ ■ ■ ■ □
■ ■ ■ ■ ■ □	■ ■ ■ ■ ■ □	■ ■ ■ ■ ■ □
page 343–344	page 355–356	page 368
page 345–354	page 357–367	page 369–371

PPN series

Polypropylene wheels, natural white



80–450 kg

Tread and tyre hardness

60 Shore D

Smooth operation / floor preservation

satisfactory

Rolling resistance

very good

Wear resistance

satisfactory

Wheel:

- high-quality polypropylene, impact resistant, hardness 60 Shore D
- low rolling and swivel resistance
- colour natural white

Other features:

- high chemical resistance to many aggressive substances
- operating temperature: -20 °C to +60 °C, reduced load capacity over +30 °C

Additional details:

- wheel series: page 68
- tread: page 57
- bearing types: page 84–85
- chemical resistance: page 51

Wheels	Wheel Ø (D) [mm]	Wheel width (T2) [mm]	Load capacity [kg]	Bearing type	Axle bore Ø (d) [mm]	Hub length (T1) [mm]
PPN 60/12G	60	29	80	plain bore	12	35
PPN 80/12G	80	32	120	plain bore	12	35
PPN 80/12R	80	32	120	roller bearing	12	35
PPN 100/12G	100	37	160	plain bore	12	45
PPN 100/12R	100	37	160	roller bearing	12	45
PPN 125/12G	125	40	200	plain bore	12	45
PPN 125/12R	125	40	200	roller bearing	12	45
PPN 150/20G	150	50	300	plain bore	20	60
PPN 150/20R	150	50	300	roller bearing	20	60
PPN 200/20G	200	50	450	plain bore	20	60
PPN 200/20R	200	50	450	roller bearing	20	60

For other dimensions, see wheel series PO on page 343–344

6

Versions / options



	electrically conductive version, colour black	with stainless steel roller bearing in the wheel hub	colour black
Technical description page	434	84	69
Product code suffix	PP...-EL series	-XR	PP series
Available for	see page 336	upon request	all see page 336

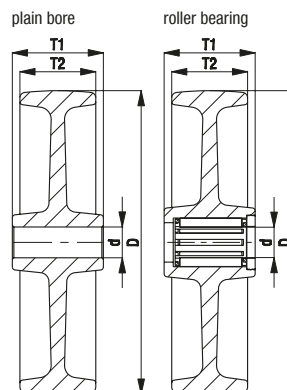

LE-PPN, B-PPN series

**Pressed steel castors
with top plate,
with polypropylene wheel, natural white**



80–300 kg

Bracket: LE/B series

- pressed steel, zinc-plated, blue-passivated, Cr6-free

Swivel bracket:

- double ball bearing in the swivel head
- swivel head seal
- minimum swivel head play and smooth rolling characteristic and increased service life due to the special dynamic Blickle riveting process

Wheel: PPN series

- high-quality polypropylene, impact resistant, hardness 60 Shore D, colour natural white

Additional details:

- bracket series: page 90
- brakes: page 112–113
- wheel series: page 332
- bearing types: page 84–85

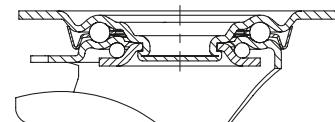

Swivel castors	Fixed castors	Swivel castors with "stop-fix" brake	Wheel Ø [mm]	Wheel width [mm]	Load capacity [kg]	Bearing type	Total height [mm]	Plate size [mm]	Bolt hole spacing [mm]	Bolt hole Ø [mm]	Offset swivel castor [mm]
LE-PPN 60G	B-PPN 60G		60	29	80	plain bore	80	100 x 85	80 x 60	9	35
LE-PPN 80G	B-PPN 80G	LE-PPN 80G-FI	80	32	120	plain bore	102	100 x 85	80 x 60	9	38
LE-PPN 80R	B-PPN 80R	LE-PPN 80R-FI	80	32	120	roller bearing	102	100 x 85	80 x 60	9	38
LE-PPN 100G	B-PPN 100G	LE-PPN 100G-FI	100	37	150	plain bore	125	100 x 85	80 x 60	9	36
LE-PPN 100R	B-PPN 100R	LE-PPN 100R-FI	100	37	150	roller bearing	125	100 x 85	80 x 60	9	36
LE-PPN 125G	B-PPN 125G	LE-PPN 125G-FI	125	40	150	plain bore	150	100 x 85	80 x 60	9	38
LE-PPN 125R	B-PPN 125R	LE-PPN 125R-FI	125	40	150	roller bearing	150	100 x 85	80 x 60	9	38
LE-PPN 150G	B-PPN 150G	LE-PPN 150G-FI	150	50	300	plain bore	190	140 x 110	105 x 75–80	11	54
LE-PPN 150R	B-PPN 150R	LE-PPN 150R-FI	150	50	300	roller bearing	190	140 x 110	105 x 75–80	11	54
LE-PPN 200G	B-PPN 200G	LE-PPN 200G-FI	200	50	300	plain bore	235	140 x 110	105 x 75–80	11	54
LE-PPN 200R	B-PPN 200R	LE-PPN 200R-FI	200	50	300	roller bearing	235	140 x 110	105 x 75–80	11	54

Versions / options



	electrically conductive version, colour black	with thread guard, pressed steel, zinc-plated	with "stop-top" brake	directional lock (separate) 1 x 360°	directional lock (separate) 1 x 360°	with steel foot guard
Technical description page	434	116	112	115	115	116
Product code suffix	PP...-EL series	-FA	-ST	RI-03.01	RI-03.03	-FS
Available for	see page 337	wheel Ø 80–200 mm	wheel Ø 150–200 mm	wheel Ø 100–125 mm*	wheel Ø 150–200 mm*	wheel Ø 100–200 mm upon request

* Only for swivel castors without brake or swivel castor with "stop-top" brake upon request

LER-PPN series

Pressed steel castors with bolt hole, with polypropylene wheel, natural white



80–300 kg

Bracket: LER series

- pressed steel, zinc-plated, blue-passivated, Cr6-free
- double ball bearing in the swivel head
- strong central kingpin
- minimum swivel head play and smooth rolling characteristic and increased service life due to the special dynamic Blickle riveting process

Wheel: PPN series

- high-quality polypropylene, impact resistant, hardness 60 Shore D, colour natural white

Additional details:

- bracket series: page 91
- brakes: page 112–113
- wheel series: page 332
- bearing types: page 84–85

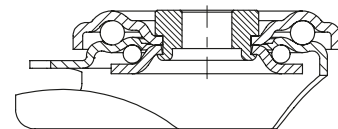

6

Swivel castors	Swivel castors with "stop-fix" brake	Wheel Ø [mm]	Wheel width [mm]	Load capacity [kg]	Bearing type	Total height [mm]	Plate Ø [mm]	Bolt hole Ø [mm]	Offset swivel castor [mm]
LER-PPN 60G		60	29	80	plain bore	80	70	13	35
LER-PPN 80G	LER-PPN 80G-FI	80	32	120	plain bore	102	70	13	38
LER-PPN 80R	LER-PPN 80R-FI	80	32	120	roller bearing	102	70	13	38
LER-PPN 100G	LER-PPN 100G-FI	100	37	150	plain bore	125	70	13	36
LER-PPN 100R	LER-PPN 100R-FI	100	37	150	roller bearing	125	70	13	36
LER-PPN 125G	LER-PPN 125G-FI	125	40	150	plain bore	150	70	13	38
LER-PPN 125R	LER-PPN 125R-FI	125	40	150	roller bearing	150	70	13	38
LER-PPN 150G	LER-PPN 150G-FI	150	50	300	plain bore	190	88	13	54
LER-PPN 150R	LER-PPN 150R-FI	150	50	300	roller bearing	190	88	13	54
LER-PPN 200G	LER-PPN 200G-FI	200	50	300	plain bore	235	88	13	54
LER-PPN 200R	LER-PPN 200R-FI	200	50	300	roller bearing	235	88	13	54

Versions / options



	electrically conductive version, colour black	with thread guard, pressed steel, zinc-plated	with steel foot guard	truck lock
Technical description page	434	116	116	114
Product code suffix	PP...-EL series	-FA	-FS	FF 100-1 / FF 125-1
Available for	see page 338	wheel Ø 80–200 mm	wheel Ø 100–200 mm upon request	wheel Ø 100+125 mm

L-PPN, B-PPN series

Pressed steel castors, medium-duty version, with top plate, with polypropylene wheel, natural white



120–400 kg

Bracket: L/B series

- pressed steel, zinc-plated, blue-passivated, Cr6-free

Swivel bracket:

- double ball bearing in the swivel head
- strong central kingpin (from wheel Ø 150 mm)
- swivel head seal
- minimum swivel head play and smooth rolling characteristic and increased service life due to the special dynamic Blickle riveting process

Wheel: PPN series

- high-quality polypropylene, impact resistant, hardness 60 Shore D, colour natural white

Additional details:

- bracket series: page 91
- brakes: page 112–113
- wheel series: page 332
- bearing types: page 84–85

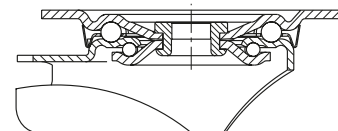

Swivel castors	Fixed castors	Swivel castors with "stop-fix" brake	Wheel Ø [mm]	Wheel width [mm]	Load capacity [kg]	Bearing type	Total height [mm]	Plate size [mm]	Bolt hole spacing [mm]	Bolt hole Ø [mm]	Offset swivel castor [mm]
L-PPN 80G	B-PPN 80G	L-PPN 80G-FI	80	32	120	plain bore	102	100 x 85	80 x 60	9	38
L-PPN 80R	B-PPN 80R	L-PPN 80R-FI	80	32	120	roller bearing	102	100 x 85	80 x 60	9	38
L-PPN 100G	B-PPN 100G	L-PPN 100G-FI	100	37	160	plain bore	125	100 x 85	80 x 60	9	36
L-PPN 100R	B-PPN 100R	L-PPN 100R-FI	100	37	160	roller bearing	125	100 x 85	80 x 60	9	36
L-PPN 125G	B-PPN 125G	L-PPN 125G-FI	125	40	200	plain bore	150	100 x 85	80 x 60	9	38
L-PPN 125R	B-PPN 125R	L-PPN 125R-FI	125	40	200	roller bearing	150	100 x 85	80 x 60	9	38
L-PPN 150G	B-PPN 150G	L-PPN 150G-FI	150	50	300	plain bore	190	140 x 110	105 x 75–80	11	60
L-PPN 150R	B-PPN 150R	L-PPN 150R-FI	150	50	300	roller bearing	190	140 x 110	105 x 75–80	11	60
L-PPN 200G	B-PPN 200G	L-PPN 200G-FI	200	50	400	plain bore	235	140 x 110	105 x 75–80	11	65
L-PPN 200R	B-PPN 200R	L-PPN 200R-FI	200	50	400	roller bearing	235	140 x 110	105 x 75–80	11	65

Versions / options



	electrically conductive version, colour black	with thread guard, pressed steel, zinc-plated	with "stop-top" brake	directional lock (separate) 1 x 360°	directional lock (separate) 1 x 360°	with steel foot guard
Technical description page	434	116	112	115	115	116
Product code suffix	PP...-EL series	-FA	-ST	RI-03.01	RI-05.03	-FS
Available for	see page 339	all	all	wheel Ø 100–125 mm*	wheel Ø 150–200 mm*	wheel Ø 100–200 mm upon request

* Only for swivel castors without brake or swivel castor with "stop-top" brake upon request

PP series

Polypropylene wheels, black

80–450 kg

Tread and tyre hardness

60 Shore D

Smooth operation / floor preservation

satisfactory

Rolling resistance

very good

Wear resistance

satisfactory

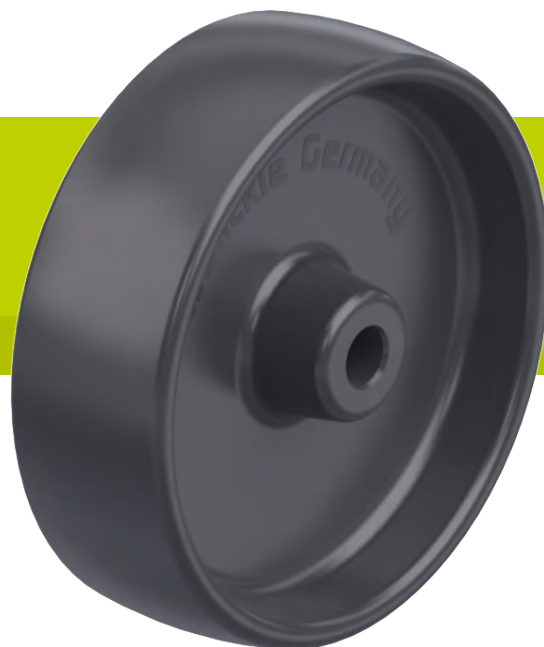

Wheel:

- high-quality polypropylene, impact resistant, hardness 60 Shore D
- low rolling and swivel resistance
- colour black

Other features:

- KA version: with synthetic thread guard, small
- high chemical resistance to many aggressive substances
- operating temperature: -20 °C to +60 °C, reduced load capacity over +30 °C

Additional details:

- wheel series: page 69
- tread: page 57
- bearing types: page 84–85
- chemical resistance: page 51

Wheels	Wheel Ø (D) [mm]	Wheel width (T2) [mm]	Load capacity [kg]	Bearing type	Axle bore Ø (d) [mm]	Hub length (T1) [mm]
PP 60/12G	60	29	80	plain bore	12	35
PP 80/12G	80	32	120	plain bore	12	35
PP 80/12R	80	32	120	roller bearing	12	35
PP 100/12G	100	37	160	plain bore	12	45
PP 100/12R	100	37	160	roller bearing	12	45
PP 100/8KA	100	37	160	ball bearing (C)	8	46
PP 125/12G	125	40	200	plain bore	12	45
PP 125/12R	125	40	200	roller bearing	12	45
PP 125/8KA	125	40	200	ball bearing (C)	8	46
PP 150/20G	150	50	300	plain bore	20	60
PP 150/20R	150	50	300	roller bearing	20	60
PP 150/20K	150	50	300	ball bearing	20	60
PP 200/20G	200	50	450	plain bore	20	60
PP 200/20R	200	50	450	roller bearing	20	60
PP 200/20K	200	50	450	ball bearing	20	60

6

Versions / options



	electrically conductive version, colour black	with stainless steel roller bearing in the wheel hub	colour natural white
Technical description page	434	84	332
Product code suffix	-EL	-XR	PPN series
Available for	all ball bearing versions	upon request	see page 332

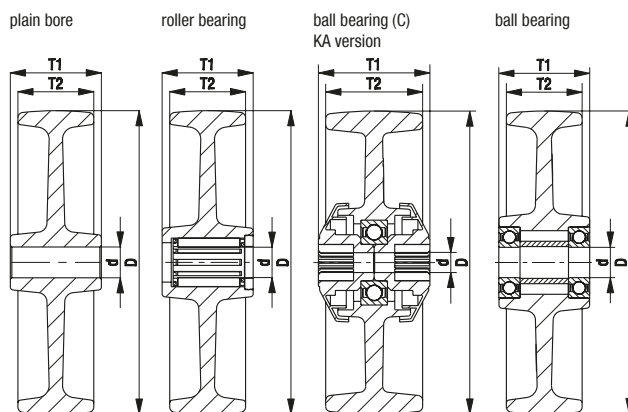

LE-PP, B-PP series

Pressed steel castors with top plate, with polypropylene wheel, black

80–300 kg

Bracket: LE/B series

- pressed steel, zinc-plated, blue-passivated, Cr6-free

Swivel bracket:

- double ball bearing in the swivel head
- swivel head seal
- minimum swivel head play and smooth rolling characteristic and increased service life due to the special dynamic Blickle riveting process

Wheel: PP series

- high-quality polypropylene, impact resistant, hardness 60 Shore D, colour black

Additional details:

- bracket series: page 90
- brakes: page 112–113
- wheel series: page 336
- bearing types: page 84–85

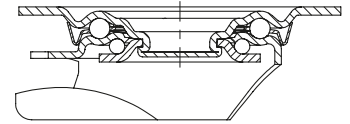

Swivel castors	Fixed castors	Swivel castors with "stop-fix" brake	Wheel Ø [mm]	Wheel width [mm]	Load capacity [kg]	Bearing type	Total height [mm]	Plate size [mm]	Bolt hole spacing [mm]	Bolt hole Ø [mm]	Offset swivel castor [mm]
LE-PP 60G	B-PP 60G		60	29	80	plain bore	80	100 x 85	80 x 60	9	35
LE-PP 80G	B-PP 80G	LE-PP 80G-FI	80	32	120	plain bore	102	100 x 85	80 x 60	9	38
LE-PP 80R	B-PP 80R	LE-PP 80R-FI	80	32	120	roller bearing	102	100 x 85	80 x 60	9	38
LE-PP 100G	B-PP 100G	LE-PP 100G-FI	100	37	150	plain bore	125	100 x 85	80 x 60	9	36
LE-PP 100R	B-PP 100R	LE-PP 100R-FI	100	37	150	roller bearing	125	100 x 85	80 x 60	9	36
LE-PP 100KA	B-PP 100KA	LE-PP 100KA-FI	100	37	150	ball bearing (C)	125	100 x 85	80 x 60	9	36
LE-PP 125G	B-PP 125G	LE-PP 125G-FI	125	40	150	plain bore	150	100 x 85	80 x 60	9	38
LE-PP 125R	B-PP 125R	LE-PP 125R-FI	125	40	150	roller bearing	150	100 x 85	80 x 60	9	38
LE-PP 125KA	B-PP 125KA	LE-PP 125KA-FI	125	40	150	ball bearing (C)	150	100 x 85	80 x 60	9	38
LE-PP 150G	B-PP 150G	LE-PP 150G-FI	150	50	300	plain bore	190	140 x 110	105 x 75–80	11	54
LE-PP 150R	B-PP 150R	LE-PP 150R-FI	150	50	300	roller bearing	190	140 x 110	105 x 75–80	11	54
LE-PP 150K	B-PP 150K	LE-PP 150K-FI	150	50	300	ball bearing	190	140 x 110	105 x 75–80	11	54
LE-PP 200G	B-PP 200G	LE-PP 200G-FI	200	50	300	plain bore	235	140 x 110	105 x 75–80	11	54
LE-PP 200R	B-PP 200R	LE-PP 200R-FI	200	50	300	roller bearing	235	140 x 110	105 x 75–80	11	54
LE-PP 200K	B-PP 200K	LE-PP 200K-FI	200	50	300	ball bearing	235	140 x 110	105 x 75–80	11	54

Versions / options



	electrically conductive version, colour black	with thread guard, pressed steel, zinc-plated	with "stop-top" brake	directional lock (separate) 1 x 360°	directional lock (separate) 1 x 360°	with steel foot guard
Technical description page	434	116	112	115	115	116
Product code suffix	-EL	-FA	-ST	RI-03.01	RI-03.03	-FS
Available for	all ball bearing versions	wheel Ø 80–200 mm	wheel Ø 150–200 mm	wheel Ø 100–125 mm*	wheel Ø 150–200 mm*	wheel Ø 100–200 mm upon request

* Only for swivel castors without brake or swivel castor with "stop-top" brake upon request

LER-PP series

Pressed steel castors with bolt hole, with polypropylene wheel, black



80–300 kg

Bracket: LER series

- pressed steel, zinc-plated, blue-passivated, Cr6-free
- double ball bearing in the swivel head
- strong central kingpin
- minimum swivel head play and smooth rolling characteristic and increased service life due to the special dynamic Blickle riveting process

Wheel: PP series

- high-quality polypropylene, impact resistant, hardness 60 Shore D, colour black

Additional details:

- bracket series: page 91
- brakes: page 112–113
- wheel series: page 336
- bearing types: page 84–85

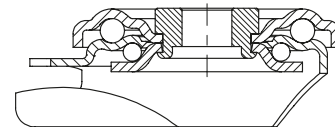

6

Swivel castors	Swivel castors with "stop-fix" brake	Wheel Ø [mm]	Wheel width [mm]	Load capacity [kg]	Bearing type	Total height [mm]	Plate Ø [mm]	Bolt hole Ø [mm]	Offset swivel castor [mm]
LER-PP 60G		60	29	80	plain bore	80	70	13	35
LER-PP 80G	LER-PP 80G-FI	80	32	120	plain bore	102	70	13	38
LER-PP 80R	LER-PP 80R-FI	80	32	120	roller bearing	102	70	13	38
LER-PP 100G	LER-PP 100G-FI	100	37	150	plain bore	125	70	13	36
LER-PP 100R	LER-PP 100R-FI	100	37	150	roller bearing	125	70	13	36
LER-PP 100KA	LER-PP 100KA-FI	100	37	150	ball bearing (C)	125	70	13	36
LER-PP 125G	LER-PP 125G-FI	125	40	150	plain bore	150	70	13	38
LER-PP 125R	LER-PP 125R-FI	125	40	150	roller bearing	150	70	13	38
LER-PP 125KA	LER-PP 125KA-FI	125	40	150	ball bearing (C)	150	70	13	38
LER-PP 150G	LER-PP 150G-FI	150	50	300	plain bore	190	88	13	54
LER-PP 150R	LER-PP 150R-FI	150	50	300	roller bearing	190	88	13	54
LER-PP 150K	LER-PP 150K-FI	150	50	300	ball bearing	190	88	13	54
LER-PP 200G	LER-PP 200G-FI	200	50	300	plain bore	235	88	13	54
LER-PP 200R	LER-PP 200R-FI	200	50	300	roller bearing	235	88	13	54
LER-PP 200K	LER-PP 200K-FI	200	50	300	ball bearing	235	88	13	54

Versions / options



	electrically conductive version, colour black	with thread guard, pressed steel, zinc-plated	with steel foot guard	truck lock
Technical description page	434	116	116	114
Product code suffix	-EL	-FA	-FS	FF 100-1 / FF 125-1
Available for	all ball bearing versions	wheel Ø 80–200 mm	wheel Ø 100–200 mm upon request	wheel Ø 100+125 mm

L-PP, B-PP series

Pressed steel castors, medium-duty version, with top plate, with polypropylene wheel, black



120–400 kg

Bracket: L/B series

- pressed steel, zinc-plated, blue-passivated, Cr6-free

Swivel bracket:

- double ball bearing in the swivel head
- strong central kingpin (from wheel Ø 150 mm)
- swivel head seal
- minimum swivel head play and smooth rolling characteristic and increased service life due to the special dynamic Blickle riveting process

Wheel: PP series

- high-quality polypropylene, impact resistant, hardness 60 Shore D, colour black

Additional details:

- bracket series: page 91
- brakes: page 112–113
- wheel series: page 336
- bearing types: page 84–85

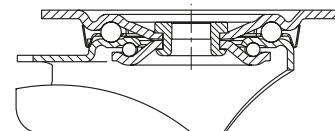

Swivel castors	Fixed castors	Swivel castors with "stop-fix" brake	Wheel Ø [mm]	Wheel width [mm]	Load capacity [kg]	Bearing type	Total height [mm]	Plate size [mm]	Bolt hole spacing [mm]	Bolt hole Ø [mm]	Offset swivel castor [mm]
L-PP 80G	B-PP 80G	L-PP 80G-FI	80	32	120	plain bore	102	100 x 85	80 x 60	9	38
L-PP 80R	B-PP 80R	L-PP 80R-FI	80	32	120	roller bearing	102	100 x 85	80 x 60	9	38
L-PP 100G	B-PP 100G	L-PP 100G-FI	100	37	160	plain bore	125	100 x 85	80 x 60	9	36
L-PP 100R	B-PP 100R	L-PP 100R-FI	100	37	160	roller bearing	125	100 x 85	80 x 60	9	36
L-PP 100KA	B-PP 100KA	L-PP 100KA-FI	100	37	160	ball bearing (C)	125	100 x 85	80 x 60	9	36
L-PP 125G	B-PP 125G	L-PP 125G-FI	125	40	200	plain bore	150	100 x 85	80 x 60	9	38
L-PP 125R	B-PP 125R	L-PP 125R-FI	125	40	200	roller bearing	150	100 x 85	80 x 60	9	38
L-PP 125KA	B-PP 125KA	L-PP 125KA-FI	125	40	200	ball bearing (C)	150	100 x 85	80 x 60	9	38
L-PP 150G	B-PP 150G	L-PP 150G-FI	150	50	300	plain bore	190	140 x 110	105 x 75–80	11	60
L-PP 150R	B-PP 150R	L-PP 150R-FI	150	50	300	roller bearing	190	140 x 110	105 x 75–80	11	60
L-PP 150K	B-PP 150K	L-PP 150K-FI	150	50	300	ball bearing	190	140 x 110	105 x 75–80	11	60
L-PP 200G	B-PP 200G	L-PP 200G-FI	200	50	400	plain bore	235	140 x 110	105 x 75–80	11	65
L-PP 200R	B-PP 200R	L-PP 200R-FI	200	50	400	roller bearing	235	140 x 110	105 x 75–80	11	65
L-PP 200K	B-PP 200K	L-PP 200K-FI	200	50	400	ball bearing	235	140 x 110	105 x 75–80	11	65

Versions / options



	electrically conductive version, colour black	with thread guard, pressed steel, zinc-plated	with "stop-top" brake	directional lock (separate) 1 x 360°	directional lock (separate) 1 x 360°	with steel foot guard
Technical description page	434	116	112	115	115	116
Product code suffix	-EL	-FA	-ST	RI-03.01	RI-05.03	-FS
Available for	all ball bearing versions	all	all	wheel Ø 100–125 mm*	wheel Ø 150–200 mm*	wheel Ø 100–200 mm upon request

* Only for swivel castors without brake or swivel castor with "stop-top" brake upon request

POW series

Low-noise nylon wheels with rubber damping ring

200–220 kg

Tread and tyre hardness

70 Shore D

Smooth operation / floor preservation

satisfactory

Rolling resistance

very good

Wear resistance

good



Tread:

- high-quality nylon 6, impact resistant, hardness 70 Shore D
- low-noise operation (-10 decibels) with elastic cushion layer made from elastic solid rubber, colour red
- easy operation on smooth surfaces
- low rolling resistance
- high abrasion resistance
- colour white

Other features:

- KF version: with synthetic thread guard, large
- high chemical resistance to many aggressive substances
- operating temperature: -20 °C to +80 °C, reduced load capacity over +35 °C

Additional details:

- wheel series: page 69
- tread: page 57
- bearing types: page 84–85
- chemical resistance: page 51

Wheels	Wheel Ø	Wheel width	Load capacity	Bearing type	Axle bore Ø	Hub length
	(D) [mm]	(T2) [mm]			(d) [mm]	(T1) [mm]
POW 100/8KF	100	35	200	ball bearing (C)	8	46
POW 100/10KF	100	35	200	ball bearing (C)	10	46
POW 125/8KF	125	35	220	ball bearing (C)	8	46
POW 125/10KF	125	35	220	ball bearing (C)	10	46

6

Versions / options



large thread guard with additional ball bearing seals

Technical description page

85

Product code suffix

-KFD

Available for

POW 100/8KF +
POW 125/8KF

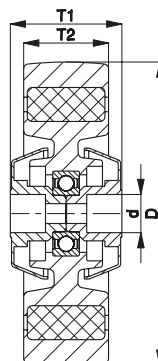

L-POW, B-POW series

Pressed steel castors, medium-duty version, with top plate, with low noise nylon wheel



200–220 kg

Bracket: L/B series

- pressed steel, zinc-plated, blue-passivated, Cr6-free

Swivel bracket:

- double ball bearing in the swivel head
- swivel head seal
- minimum swivel head play and smooth rolling characteristic and increased service life due to the special dynamic Blickle riveting process

Wheel: POW series

- high-quality nylon 6, impact resistant, hardness 70 Shore D, colour white
- low-noise operation (-10 decibels) with elastic cushion layer made from elastic solid rubber, colour red

Additional details:

- bracket series: page 91
- brakes: page 112–113
- wheel series: page 340
- bearing types: page 84–85

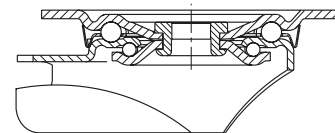

Swivel castors	Fixed castors	Swivel castors with "stop-fix" brake	Wheel Ø [mm]	Wheel width [mm]	Load capacity [kg]	Bearing type	Total height [mm]	Plate size [mm]	Bolt hole spacing [mm]	Bolt hole Ø [mm]	Offset swivel castor [mm]
L-POW 100KF	B-POW 100KF	L-POW 100KF-FI	100	35	200	ball bearing (C)	125	100 x 85	80 x 60	9	36
L-POW 125KF	B-POW 125KF	L-POW 125KF-FI	125	35	220	ball bearing (C)	150	100 x 85	80 x 60	9	38

6

Versions / options



	directional lock (separate) 1 x 360°	large thread guard with additional ball bearing seals
Technical description page	115	85
Product code suffix	RI-03.01	-KFD
Available for	all*	upon request

* Only for swivel castors without brake

LK-POW, BK-POW series

**Pressed steel castors, heavy-duty design,
with top plate,
with low noise nylon wheel**



200–220 kg

Bracket: LK/BK series

- strong pressed steel, zinc-plated, blue-passivated, Cr6-free

Swivel bracket:

- double ball bearing in the swivel head
- swivel head seal
- minimum swivel head play and smooth rolling characteristic and increased service life due to the special dynamic Blickle riveting process

Wheel: POW series

- high-quality nylon 6, impact resistant, hardness 70 Shore D, colour white
- low-noise operation (-10 decibels) with elastic cushion layer made from elastic solid rubber, colour red

Additional details:

- bracket series: page 92
- brakes: page 112–113
- wheel series: page 340
- bearing types: page 84–85

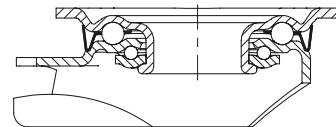

6

Swivel castors	Fixed castors	Swivel castors with "stop-fix" brake	Wheel Ø [mm]	Wheel width [mm]	Load capacity [kg]	Bearing type	Total height [mm]	Plate size [mm]	Bolt hole spacing [mm]	Bolt hole Ø [mm]	Offset swivel castor [mm]
LK-POW 100KF-1	BK-POW 100KF-1	LK-POW 100KF-1-FI	100	35	200	ball bearing (C)	130	100 x 85	80 x 60	9	45
LK-POW 100KF-3	BK-POW 100KF-3	LK-POW 100KF-3-FI	100	35	200	ball bearing (C)	130	140 x 110	105 x 75–80	11	45
LK-POW 125KF-1	BK-POW 125KF-1	LK-POW 125KF-1-FI	125	35	220	ball bearing (C)	155	100 x 85	80 x 60	9	48
LK-POW 125KF-3	BK-POW 125KF-3	LK-POW 125KF-3-FI	125	35	220	ball bearing (C)	155	140 x 110	105 x 75–80	11	48

Versions / options



	directional lock (separate) 1 x 360°	directional lock (separate) 1 x 360°
Technical description page	115	115
Product code suffix	RI-05.01	RI-03.03
Available for	all with plate 100x85 mm *	all with plate 140x110 mm *

* Only for swivel castors without brake

PO series, wheel Ø 50–125x40 mm

Nylon wheels



75–300 kg

Tread and tyre hardness

70 Shore D

Smooth operation / floor preservation

satisfactory

Rolling resistance

excellent

Wear resistance

good

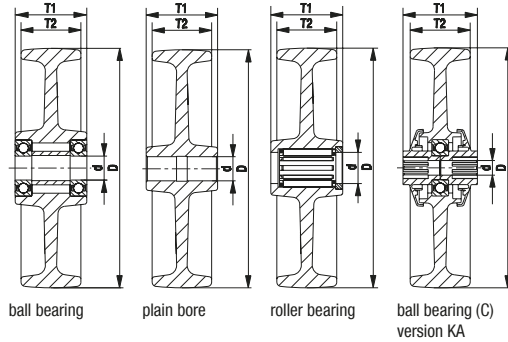

Wheel:

- high-quality nylon 6, impact resistant, hardness 70 Shore D
- excellent rolling and swivel resistance
- easy operation on smooth surfaces
- high abrasion resistance
- colour natural white

Other features:

- KA version: with synthetic thread guard, small
- KF version: with synthetic thread guard, large
- high chemical resistance to many aggressive substances
- operating temperature: -20 °C to +80 °C, reduced load capacity over +35 °C

Additional details:

- wheel series: page 69
- tread: page 57
- bearing types: page 84–85
- chemical resistance: page 51

Wheels	Wheel Ø (D) [mm]	Wheel width (T2) [mm]	Load capacity [kg]	Bearing type	Axle bore Ø (d) [mm]	Hub length (T1) [mm]
PO 50/8G	50	18	75	plain bore	8	22
PO 60/12G	60	29	150	plain bore	12	35
PO 60/8KF	60	32	150	ball bearing (C)	8	36
PO 76/8G	75	23	100	plain bore	8	29.5
PO 75/12G	75	32	200	plain bore	12	35
PO 75/12-45G	75	32	200	plain bore	12	45
PO 75/12R	75	32	200	roller bearing	12	35
PO 80/12G	80	32	220	plain bore	12	35
PO 80/12R	80	32	220	roller bearing	12	35
PO 80/8KA	80	32	220	ball bearing (C)	8	36
PO 82/15G	80	37	230	plain bore	15	45
PO 82/15R	80	37	230	roller bearing	15	45
PO 82/15K	80	37	250	ball bearing	15	45
PO 101/12G	100	32	240	plain bore	12	35
PO 100/12G	100	37	280	plain bore	12	45
PO 100/15G	100	37	280	plain bore	15	45
PO 100/12R	100	37	280	roller bearing	12	45
PO 100/15R	100	37	280	roller bearing	15	45
PO 100/8KA	100	37	280	ball bearing (C)	8	46
PO 100/10KA	100	37	280	ball bearing (C)	10	46
PO 126/12G	125	32	260	plain bore	12	35
PO 125/12G	125	40	300	plain bore	12	45
PO 125/15G	125	40	300	plain bore	15	45
PO 125/20G	125	40	300	plain bore	20	45
PO 125/12R	125	40	300	roller bearing	12	45
PO 125/15R	125	40	300	roller bearing	15	45
PO 125/8KA	125	40	300	ball bearing (C)	8	46
PO 125/10KA	125	40	300	ball bearing (C)	10	46

For other wheel Ø, see next page

Versions / options



	electrically conductive version, non-marking grey	with stainless steel roller bearing in the wheel hub	with stainless steel ball bearing and thread guard	wheel in special colour blue
Technical description page	50	84	84–85	
Product code suffix	-ELS	-XR	-XKA / -XKF	-C5017
Available for	see series PO...-ELS (page 435)	all roller bearing wheels	version ball bearing (C)	PO 100/12G, PO 125/15G

PO series, wheel Ø 125x50–300 mm

Nylon wheels



350–1,500 kg

Tread and tyre hardness

70 Shore D

Smooth operation / floor preservation

satisfactory

Rolling resistance

excellent

Wear resistance

good

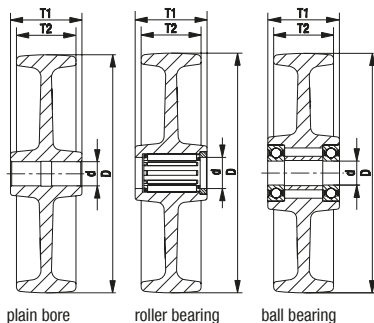

plain bore roller bearing ball bearing

Wheel:

- high-quality nylon 6, impact resistant, hardness 70 Shore D
- excellent rolling and swivel resistance
- easy operation on smooth surfaces
- high abrasion resistance
- colour natural white

Other features:

- high chemical resistance to many aggressive substances
- operating temperature: -20 °C to +80 °C, reduced load capacity over +35 °C

Additional details:

- wheel series: page 69
- tread: page 57
- bearing types: page 84–85
- chemical resistance: page 51

Wheels	Wheel Ø (D) [mm]	Wheel width (T2) [mm]	Load capacity [kg]	Bearing type	Axle bore Ø (d) [mm]	Hub length (T1) [mm]
PO 127/20R	125	50	400	roller bearing	20	60
PO 127/20K	125	50	400	ball bearing	20	60
PO 151/15G	150	40	350	plain bore	15	50
PO 151/20G	150	40	350	plain bore	20	50
PO 150/20G	150	50	400	plain bore	20	60
PO 150/20R	150	50	400	roller bearing	20	60
PO 150/20K	150	50	400	ball bearing	20	60
PO 160/20G	160	50	450	plain bore	20	60
PO 160/20R	160	50	450	roller bearing	20	60
PO 160/20K	160	50	450	ball bearing	20	60
PO 175/20G	175	50	500	plain bore	20	60
PO 175/20R	175	50	500	roller bearing	20	60
PO 175/20K	175	50	500	ball bearing	20	60
PO 201/15G	200	40	500	plain bore	15	50
PO 201/20G	200	40	500	plain bore	20	50
PO 200/20G	200	50	600	plain bore	20	60
PO 200/20R	200	50	600	roller bearing	20	60
PO 200/20K	200	50	600	ball bearing	20	60
PO 200/25K	200	50	600	ball bearing	25	60
PO 250/25G	250	50	1,000	plain bore	25	60
PO 250/25K	250	50	1,000	ball bearing	25	60
PO 300/30G	300	55	1,500	plain bore	30	65
PO 300/30K	300	55	1,500	ball bearing	30	65

6

Versions / options



	electrically conductive version, non-marking grey	with grease nipple	with stainless steel roller bearing in the wheel hub	with stainless steel ball bearing in the wheel hub	wheel in special colour blue
Technical description page	50		84	84	
Product code suffix	-ELS	-NI	-XR	-XK	-C5017
Available for	see series PO...-ELS (page 435)	upon request	all roller bearing wheels	all ball bearing wheels	PO 151/20G, PO 200/20G

LE-PO, B-PO series

Pressed steel castors with top plate, with nylon wheel

150–300 kg



Bracket: LE/B series

- pressed steel, zinc-plated, blue-passivated, Cr6-free

Swivel bracket:

- double ball bearing in the swivel head
- swivel head seal
- minimum swivel head play and smooth rolling characteristic and increased service life due to the special dynamic Blickle riveting process

Wheel: PO series

- high-quality nylon 6, impact resistant, hardness 70 Shore D, colour natural white

Additional details:

- bracket series: page 90
- brakes: page 112–113
- wheel series: page 343–344
- bearing types: page 84–85

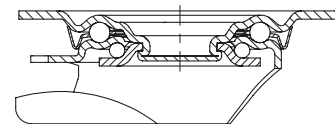

Swivel castors	Fixed castors	Swivel castors with "stop-fix" brake	Wheel Ø [mm]	Wheel width [mm]	Load capacity [kg]	Bearing type	Total height [mm]	Plate size [mm]	Bolt hole spacing [mm]	Bolt hole Ø [mm]	Offset swivel castor [mm]
LE-PO 60G	B-PO 60G	LE-PO 60G-RA *	60	29	150	plain bore	80	100 x 85	80 x 60	9	35
LE-PO 60KF	B-PO 60KF	LE-PO 60KF-RA *	60	32	150	ball bearing (C)	80	100 x 85	80 x 60	9	35
LE-PO 75G	B-PO 75G	LE-PO 75G-FI	75	32	150	plain bore	100	100 x 85	80 x 60	9	38
LE-PO 75R	B-PO 75R	LE-PO 75R-FI	75	32	150	roller bearing	100	100 x 85	80 x 60	9	38
LE-PO 80G	B-PO 80G	LE-PO 80G-FI	80	32	150	plain bore	102	100 x 85	80 x 60	9	38
LE-PO 80R	B-PO 80R	LE-PO 80R-FI	80	32	150	roller bearing	102	100 x 85	80 x 60	9	38
LE-PO 80KA	B-PO 80KA	LE-PO 80KA-FI	80	32	150	ball bearing (C)	102	100 x 85	80 x 60	9	38
LE-PO 100G	B-PO 100G	LE-PO 100G-FI	100	37	150	plain bore	125	100 x 85	80 x 60	9	36
LE-PO 100R	B-PO 100R	LE-PO 100R-FI	100	37	150	roller bearing	125	100 x 85	80 x 60	9	36
LE-PO 100KA	B-PO 100KA	LE-PO 100KA-FI	100	37	150	ball bearing (C)	125	100 x 85	80 x 60	9	36
LE-PO 125G	B-PO 125G	LE-PO 125G-FI	125	40	150	plain bore	150	100 x 85	80 x 60	9	38
LE-PO 125R	B-PO 125R	LE-PO 125R-FI	125	40	150	roller bearing	150	100 x 85	80 x 60	9	38
LE-PO 125KA	B-PO 125KA	LE-PO 125KA-FI	125	40	150	ball bearing (C)	150	100 x 85	80 x 60	9	38
LE-PO 150G	B-PO 150G	LE-PO 150G-FI	150	50	300	plain bore	190	140 x 110	105 x 75–80	11	54
LE-PO 150R	B-PO 150R	LE-PO 150R-FI	150	50	300	roller bearing	190	140 x 110	105 x 75–80	11	54
LE-PO 160G	B-PO 160G	LE-PO 160G-FI	160	50	300	plain bore	195	140 x 110	105 x 75–80	11	54
LE-PO 160R	B-PO 160R	LE-PO 160R-FI	160	50	300	roller bearing	195	140 x 110	105 x 75–80	11	54
LE-PO 175G	B-PO 175G	LE-PO 175G-FI	175	50	300	plain bore	213	140 x 110	105 x 75–80	11	50
LE-PO 175R	B-PO 175R	LE-PO 175R-FI	175	50	300	roller bearing	213	140 x 110	105 x 75–80	11	50
LE-PO 200G	B-PO 200G	LE-PO 200G-FI	200	50	300	plain bore	235	140 x 110	105 x 75–80	11	54
LE-PO 200R	B-PO 200R	LE-PO 200R-FI	200	50	300	roller bearing	235	140 x 110	105 x 75–80	11	54

* "Radstop" brake version

For stainless steel versions, see page 417

Versions / options



	"Radstop" wheel brake	electrically conductive version, non-marking grey	with thread guard, pressed steel, zinc-plated	with "stop-top" brake	with directional lock (separate) 1x 360°	with stainless steel ball bearing and small thread guard	with steel foot guard
Technical description page	50	116	112	115	85	116	
Product code suffix	-ELS	-FA	-ST	see **	-XKA	-FS	
Available for	see series PO...-ELS (page 435)	wheel Ø 75–200 mm	wheel Ø 150–200 mm	for wheel Ø and plate dimensions, see**	version ball bearing (C) upon request	upon request	

** RI-03.01 for wheel Ø 75, 100, 125 mm, RI-03.03 for wheel Ø 150–200 mm (Only for swivel castors without brake or swivel castor with "stop-top" brake upon request)

LER-PO series

Pressed steel castors with bolt hole, with nylon wheel

150–300 kg

Bracket: LER series

- pressed steel, zinc-plated, blue-passivated, Cr6-free
- double ball bearing in the swivel head
- strong central kingpin
- minimum swivel head play and smooth rolling characteristic and increased service life due to the special dynamic Blickle riveting process

Wheel: PO series

- high-quality nylon 6, impact resistant, hardness 70 Shore D, colour natural white

Additional details:

- bracket series: page 91
- brakes: page 112–113
- wheel series: page 343–344
- bearing types: page 84–85

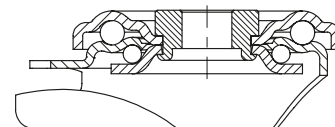

6

Swivel castors	Swivel castors with "stop-fix" brake	Wheel Ø [mm]	Wheel width [mm]	Load capacity [kg]	Bearing type	Total height [mm]	Plate Ø [mm]	Bolt hole Ø [mm]	Offset swivel castor [mm]
LER-PO 60G	LER-PO 60G-RA *	60	29	150	plain bore	80	70	13	35
LER-PO 60KF	LER-PO 60KF-RA *	60	32	150	ball bearing (C)	80	70	13	35
LER-PO 75G	LER-PO 75G-FI	75	32	150	plain bore	100	70	13	38
LER-PO 75R	LER-PO 75R-FI	75	32	150	roller bearing	100	70	13	38
LER-PO 80G	LER-PO 80G-FI	80	32	150	plain bore	102	70	13	38
LER-PO 80R	LER-PO 80R-FI	80	32	150	roller bearing	102	70	13	38
LER-PO 80KA	LER-PO 80KA-FI	80	32	150	ball bearing (C)	102	70	13	38
LER-PO 100G	LER-PO 100G-FI	100	37	150	plain bore	125	70	13	36
LER-PO 100R	LER-PO 100R-FI	100	37	150	roller bearing	125	70	13	36
LER-PO 100KA	LER-PO 100KA-FI	100	37	150	ball bearing (C)	125	70	13	36
LER-PO 125G	LER-PO 125G-FI	125	40	150	plain bore	150	70	13	38
LER-PO 125R	LER-PO 125R-FI	125	40	150	roller bearing	150	70	13	38
LER-PO 125KA	LER-PO 125KA-FI	125	40	150	ball bearing (C)	150	70	13	38
LER-PO 150G	LER-PO 150G-FI	150	50	300	plain bore	190	88	13	54
LER-PO 150R	LER-PO 150R-FI	150	50	300	roller bearing	190	88	13	54
LER-PO 160G	LER-PO 160G-FI	160	50	300	plain bore	195	88	13	54
LER-PO 160R	LER-PO 160R-FI	160	50	300	roller bearing	195	88	13	54
LER-PO 175G	LER-PO 175G-FI	175	50	300	plain bore	213	88	13	50
LER-PO 175R	LER-PO 175R-FI	175	50	300	roller bearing	213	88	13	50
LER-PO 200G	LER-PO 200G-FI	200	50	300	plain bore	235	88	13	54
LER-PO 200R	LER-PO 200R-FI	200	50	300	roller bearing	235	88	13	54

* "Radstop" brake version

For stainless steel versions, see page 418

Versions / options



	"Radstop" wheel brake	electrically conductive version, non-marking grey	with thread guard, pressed steel, zinc-plated	with stainless steel ball bearing and small thread guard	with steel foot guard	truck lock
Technical description page		50	116	85	116	114
Product code suffix		-ELS	-FA	-XKA	-FS	FF 100-1 / FF 125-1
Available for		see series PO...-ELS (page 435)	wheel Ø 75–200 mm	version ball bearing (C) upon request	wheel Ø 100–200 mm upon request	wheel Ø 100+125 mm

LEZ-PO series

Pressed steel castors with stem, with nylon wheel

150–300 kg

Bracket: LEZ series

- pressed steel, zinc-plated, blue-passivated, Cr6-free
- double ball bearing in the swivel head
- minimum swivel head play and smooth rolling characteristic and increased service life due to the special dynamic Blickle riveting process
- steel plug-in stem and central kingpin bolted and secured

Wheel: PO series

- high-quality nylon 6, impact resistant, hardness 70 Shore D, colour natural white

Additional details:

- bracket series: page 91
- brakes: page 112–113
- wheel series: page 343–344
- bearing types: page 84–85

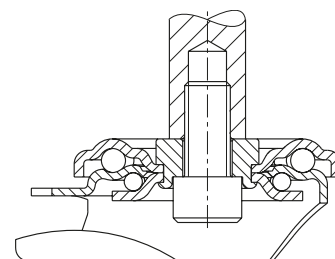

Swivel castors	Swivel castors with "stop-fix" brake	Wheel Ø [mm]	Wheel width [mm]	Load capacity [kg]	Bearing type	Total height [mm]	Stem Ø (D) [mm]	Stem length [mm]	Offset swivel castor [mm]
LEZ-PO 75G	LEZ-PO 75G-FI	75	32	150	plain bore	100	20	50	38
LEZ-PO 80G	LEZ-PO 80G-FI	80	32	150	plain bore	102	20	50	38
LEZ-PO 100G	LEZ-PO 100G-FI	100	37	150	plain bore	125	20	50	36
LEZ-PO 125G	LEZ-PO 125G-FI	125	40	150	plain bore	150	20	50	38
LEZ-PO 150G-22	LEZ-PO 150G-22-FI	150	50	300	plain bore	190	22	60	54
LEZ-PO 150G-27	LEZ-PO 150G-27-FI	150	50	300	plain bore	190	27	60	54
LEZ-PO 160G-22	LEZ-PO 160G-22-FI	160	50	300	plain bore	195	22	60	54
LEZ-PO 160G-27	LEZ-PO 160G-27-FI	160	50	300	plain bore	195	27	60	54
LEZ-PO 200G-22	LEZ-PO 200G-22-FI	200	50	300	plain bore	235	22	60	54
LEZ-PO 200G-27	LEZ-PO 200G-27-FI	200	50	300	plain bore	235	27	60	54

For stainless steel versions, see page 419

Versions / options



	electrically conductive version, non-marking grey	with thread guard, pressed steel, zinc-plated	with steel foot guard	truck lock
Technical description page	50	116	116	114
Product code suffix	-ELS	-FA	-FS	FF 100-1 / FF 125-1
Available for	see series PO...-ELS (page 435)	all	wheel Ø 100–200 mm upon request	wheel Ø 100+125 mm

L-PO, B-PO series, wheel Ø 75–150 mm

Pressed steel castors, medium-duty version, with top plate, with nylon wheel

200–400 kg



Bracket: L/B series

- pressed steel, zinc-plated, blue-passivated, Cr6-free

Swivel bracket:

- double ball bearing in the swivel head
- strong central kingpin (from wheel Ø 150 mm)
- swivel head seal
- minimum swivel head play and smooth rolling characteristic and increased service life due to the special dynamic Blickle riveting process

Wheel: PO series

- high-quality nylon 6, impact resistant, hardness 70 Shore D, colour natural white

Additional details:

- bracket series: page 91
- brakes: page 112–113
- wheel series: page 343–344
- bearing types: page 84–85

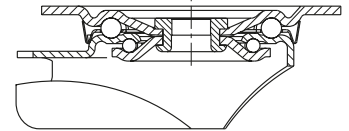

6

Swivel castors	Fixed castors	Swivel castors with "stop-fix" brake	Wheel Ø [mm]	Wheel width [mm]	Load capacity [kg]	Bearing type	Total height [mm]	Plate size [mm]	Bolt hole spacing [mm]	Bolt hole Ø [mm]	Offset swivel castor [mm]
L-PO 75G	B-PO 75G	L-PO 75G-FI	75	32	200	plain bore	100	100 x 85	80 x 60	9	38
L-PO 75R	B-PO 75R	L-PO 75R-FI	75	32	200	roller bearing	100	100 x 85	80 x 60	9	38
L-PO 80G	B-PO 80G	L-PO 80G-FI	80	32	220	plain bore	102	100 x 85	80 x 60	9	38
L-PO 80R	B-PO 80R	L-PO 80R-FI	80	32	220	roller bearing	102	100 x 85	80 x 60	9	38
L-PO 80KA	B-PO 80KA	L-PO 80KA-FI	80	32	220	ball bearing (C)	102	100 x 85	80 x 60	9	38
L-PO 100G	B-PO 100G	L-PO 100G-FI	100	37	250	plain bore	125	100 x 85	80 x 60	9	36
L-PO 100R	B-PO 100R	L-PO 100R-FI	100	37	250	roller bearing	125	100 x 85	80 x 60	9	36
L-PO 100KA	B-PO 100KA	L-PO 100KA-FI	100	37	250	ball bearing (C)	125	100 x 85	80 x 60	9	36
L-PO 125G	B-PO 125G	L-PO 125G-FI	125	40	250	plain bore	150	100 x 85	80 x 60	9	38
L-PO 125R	B-PO 125R	L-PO 125R-FI	125	40	250	roller bearing	150	100 x 85	80 x 60	9	38
L-PO 125KA	B-PO 125KA	L-PO 125KA-FI	125	40	250	ball bearing (C)	150	100 x 85	80 x 60	9	38
L-PO 150G	B-PO 150G	L-PO 150G-FI	150	50	400	plain bore	190	140 x 110	105 x 75–80	11	60
L-PO 150R	B-PO 150R	L-PO 150R-FI	150	50	400	roller bearing	190	140 x 110	105 x 75–80	11	60
L-PO 150K	B-PO 150K	L-PO 150K-FI	150	50	400	ball bearing	190	140 x 110	105 x 75–80	11	60

For other wheel Ø, see next page

For stainless steel versions, see page 420

Versions / options



	electrically conductive version, non-marking grey	with thread guard, pressed steel, zinc-plated	with "stop-top" brake	with directional lock (separate) 1x 360°	with stainless steel roller bearing in the wheel hub	with stainless steel ball bearing in the wheel hub	with steel foot guard
Technical description page	50	116	112	115	84	84 / 85	116
Product code suffix	-ELS	-FA	-ST	see *	-XR	-XK / -XKA	-FS
Available for	see series PO...-ELS (page 435)	all	all	for wheel Ø and plate dimensions, see*	all roller bearing wheels	all ball bearing wheels upon request	wheel Ø 100–150 mm

* RI-03.01 for wheel Ø 75, 100, 125 mm, RI-05.03 for wheel Ø 150 mm (Only for swivel castors without brake or swivel castor with "stop-top" brake upon request)

L-PO, B-PO, BH-PO series, wheel Ø 160–250 mm
**Pressed steel castors, medium-duty version,
 with top plate,
 with nylon wheel**



400–600 kg

Bracket: L/B/BH series

- pressed steel, zinc-plated, blue-passivated, Cr6-free

Swivel bracket:

- double ball bearing in the swivel head
- strong central kingpin
- swivel head seal (exception: plate size 175 x 175 mm)
- minimum swivel head play and smooth rolling characteristic and increased service life due to the special dynamic Blickle riveting process

Wheel: PO series

- high-quality nylon 6, impact resistant, hardness 70 Shore D, colour natural white

Additional details:

- bracket series: page 91
- brakes: page 112–113
- wheel series: page 343–344
- bearing types: page 84–85

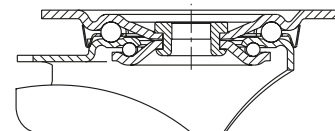

Swivel castors	Fixed castors	Swivel castors with "stop-fix" brake	Wheel Ø [mm]	Wheel width [mm]	Load capacity [kg]	Bearing type	Total height [mm]	Plate size [mm]	Bolt hole spacing [mm]	Bolt hole Ø [mm]	Offset swivel castor [mm]
L-PO 160G	B-PO 160G	L-PO 160G-FI	160	50	400	plain bore	195	140 x 110	105 x 75–80	11	60
L-PO 160R	B-PO 160R	L-PO 160R-FI	160	50	400	roller bearing	195	140 x 110	105 x 75–80	11	60
L-PO 160K	B-PO 160K	L-PO 160K-FI	160	50	400	ball bearing	195	140 x 110	105 x 75–80	11	60
L-PO 175G	B-PO 175G	L-PO 175G-FI	175	50	400	plain bore	213	140 x 110	105 x 75–80	11	60
L-PO 175R	B-PO 175R	L-PO 175R-FI	175	50	400	roller bearing	213	140 x 110	105 x 75–80	11	60
L-PO 175K	B-PO 175K	L-PO 175K-FI	175	50	400	ball bearing	213	140 x 110	105 x 75–80	11	60
L-PO 200G	B-PO 200G	L-PO 200G-FI	200	50	400	plain bore	235	140 x 110	105 x 75–80	11	65
L-PO 200R	B-PO 200R	L-PO 200R-FI	200	50	400	roller bearing	235	140 x 110	105 x 75–80	11	65
L-PO 200K	B-PO 200K	L-PO 200K-FI	200	50	400	ball bearing	235	140 x 110	105 x 75–80	11	65
L-PO 250G-3	BH-PO 250G	*	250	50	500	plain bore	295	140 x 110	105 x 75–80	11	77
L-PO 250K-3	BH-PO 250K	*	250	50	500	ball bearing	295	140 x 110	105 x 75–80	11	77
L-PO 250G		*	250	50	600	plain bore	295	175 x 175	140 x 140	15	70
	B-PO 250G		250	50	600	plain bore	295	220 x 130	190 x 75	15	–

* "stop-top" brake version, see versions / options

For stainless steel versions, see page 420

Versions / options**



	electrically conductive version, non-marking grey	with thread guard, pressed steel, zinc-plated	with "stop-top" brake	with "central-stop" central brake system	with stainless steel roller bearing in the wheel hub	with stainless steel ball bearing in the wheel hub	with steel foot guard
Technical description page	50	116	112	113	84	84	116
Product code suffix	-ELS	-FA	-ST	-CS11	-XR	-XK	-FS
Available for	see series PO...-ELS (page 435)	wheel Ø 160–200 mm	all	wheel Ø 160+200 mm	all roller bearing wheels	all ball bearing wheels upon request	wheel Ø 160–200 mm, wheel Ø 250 mm upon request

** Other versions / options: directional lock (separate) 1 x 360°: **RI-05.03** for wheel Ø 160–200 mm (only for swivel castors without brake or swivel castor with "stop-top" and "central-stop" brake upon request)

LK-PO, BK-PO series, wheel Ø 75–125x40 mm

Pressed steel castors, heavy-duty design, with top plate, with nylon wheel

200–300 kg

Bracket: LK/BK series

- strong pressed steel, zinc-plated, blue-passivated, Cr6-free

Swivel bracket:

- double ball bearing in the swivel head
- swivel head seal
- minimum swivel head play and smooth rolling characteristic and increased service life due to the special dynamic Blickle riveting process

Wheel: PO series

- high-quality nylon 6, impact resistant, hardness 70 Shore D, colour natural white

Additional details:

- bracket series: page 92
- brakes: page 112–113
- wheel series: page 343–344
- bearing types: page 84–85

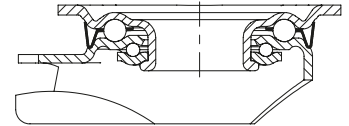

6

Swivel castors	Fixed castors	Swivel castors with "stop-fix" brake	Wheel Ø [mm]	Wheel width [mm]	Load capacity [kg]	Bearing type	Total height [mm]	Plate size [mm]	Bolt hole spacing [mm]	Bolt hole Ø [mm]	Offset swivel castor [mm]
LK-PO 75G	BK-PO 75G	LK-PO 75G-FI	75	32	200	plain bore	108	100 x 85	80 x 60	9	40
LK-PO 75R	BK-PO 75R	LK-PO 75R-FI	75	32	200	roller bearing	108	100 x 85	80 x 60	9	40
LK-PO 82G	BK-PO 82G	LK-PO 82G-FI	80	37	230	plain bore	110	100 x 85	80 x 60	9	40
LK-PO 82R	BK-PO 82R	LK-PO 82R-FI	80	37	230	roller bearing	110	100 x 85	80 x 60	9	40
LK-PO 82K	BK-PO 82K	LK-PO 82K-FI	80	37	250	ball bearing	110	100 x 85	80 x 60	9	40
LK-PO 100G-1	BK-PO 100G-1	LK-PO 100G-1-FI	100	37	280	plain bore	130	100 x 85	80 x 60	9	45
LK-PO 100R-1	BK-PO 100R-1	LK-PO 100R-1-FI	100	37	280	roller bearing	130	100 x 85	80 x 60	9	45
LK-PO 100KA-1	BK-PO 100KA-1	LK-PO 100KA-1-FI	100	37	280	ball bearing (C)	130	100 x 85	80 x 60	9	45
LK-PO 100G-3	BK-PO 100G-3	LK-PO 100G-3-FI	100	37	280	plain bore	130	140 x 110	105 x 75–80	11	45
LK-PO 100R-3	BK-PO 100R-3	LK-PO 100R-3-FI	100	37	280	roller bearing	130	140 x 110	105 x 75–80	11	45
LK-PO 100KA-3	BK-PO 100KA-3	LK-PO 100KA-3-FI	100	37	280	ball bearing (C)	130	140 x 110	105 x 75–80	11	45
LK-PO 125G-1	BK-PO 125G-1	LK-PO 125G-1-FI	125	40	300	plain bore	155	100 x 85	80 x 60	9	48
LK-PO 125R-1	BK-PO 125R-1	LK-PO 125R-1-FI	125	40	300	roller bearing	155	100 x 85	80 x 60	9	48
LK-PO 125KA-1	BK-PO 125KA-1	LK-PO 125KA-1-FI	125	40	300	ball bearing (C)	155	100 x 85	80 x 60	9	48
LK-PO 125G-3	BK-PO 125G-3	LK-PO 125G-3-FI	125	40	300	plain bore	155	140 x 110	105 x 75–80	11	48
LK-PO 125R-3	BK-PO 125R-3	LK-PO 125R-3-FI	125	40	300	roller bearing	155	140 x 110	105 x 75–80	11	48
LK-PO 125KA-3	BK-PO 125KA-3	LK-PO 125KA-3-FI	125	40	300	ball bearing (C)	155	140 x 110	105 x 75–80	11	48

For other wheel Ø, see next page

Versions / options



	electrically conductive version, non-marking grey	with thread guard, pressed steel, zinc-plated	with "stop-top" brake	with directional lock (separate) 1x 360°	with stainless steel roller bearing in the wheel hub	with stainless steel ball bearing in the wheel hub
Technical description page	50	116	112	115	84	84 / 85
Product code suffix	-ELS	-FA	-ST	see *	-XR	-XK / -XKA
Available for	see series PO...ELS (page 435)	all	all	for wheel Ø and plate dimensions, see*	all roller bearing wheels	all ball bearing wheels upon request

* RI-05.01 for wheel Ø 75–125 mm with plate 100x85 mm, RI-03.03 for wheel Ø 100–125 mm with plate 140x110 mm (Only for swivel castors without brake or swivel castor with "stop-top" brake upon request)

LK-PO, BH-PO series, wheel Ø 125x50–200 mm

**Pressed steel castors, heavy-duty design,
with top plate,
with nylon wheel**

400–600 kg



Bracket: LK/BH series

- strong pressed steel, zinc-plated, blue-passivated, Cr6-free

Swivel bracket:

- double ball bearing in the swivel head
- strong central kingpin
- swivel head seal
- minimum swivel head play and smooth rolling characteristic and increased service life due to the special dynamic Blickle riveting process

Wheel: PO series

- high-quality nylon 6, impact resistant, hardness 70 Shore D, colour natural white

Additional details:

- bracket series: page 92
- brakes: page 112–113
- wheel series: page 343–344
- bearing types: page 84–85

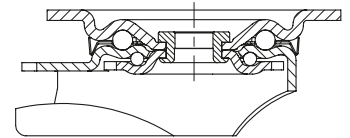

Swivel castors	Fixed castors	Swivel castors with "stop-fix" brake	Wheel Ø [mm]	Wheel width [mm]	Load capacity [kg]	Bearing type	Total height [mm]	Plate size [mm]	Bolt hole spacing [mm]	Bolt hole Ø [mm]	Offset swivel castor [mm]
LK-PO 127R	BH-PO 127R	LK-PO 127R-FI	125	50	400	roller bearing	170	140 x 110	105 x 75–80	11	55
LK-PO 127K	BH-PO 127K	LK-PO 127K-FI	125	50	400	ball bearing	170	140 x 110	105 x 75–80	11	55
LK-PO 150G	BH-PO 150G	LK-PO 150G-FI	150	50	400	plain bore	197	140 x 110	105 x 75–80	11	60
LK-PO 150K	BH-PO 150K	LK-PO 150K-FI	150	50	400	ball bearing	197	140 x 110	105 x 75–80	11	60
LK-PO 160G	BH-PO 160G	LK-PO 160G-FI	160	50	450	plain bore	202	140 x 110	105 x 75–80	11	60
LK-PO 160K	BH-PO 160K	LK-PO 160K-FI	160	50	450	ball bearing	202	140 x 110	105 x 75–80	11	60
LK-PO 175G	BH-PO 175G	LK-PO 175G-FI	175	50	500	plain bore	220	140 x 110	105 x 75–80	11	65
LK-PO 175K	BH-PO 175K	LK-PO 175K-FI	175	50	500	ball bearing	220	140 x 110	105 x 75–80	11	65
LK-PO 200G	BH-PO 200G	LK-PO 200G-FI	200	50	600	plain bore	245	140 x 110	105 x 75–80	11	62
LK-PO 200K	BH-PO 200K	LK-PO 200K-FI	200	50	600	ball bearing	245	140 x 110	105 x 75–80	11	62

6

Versions / options *



	electrically conductive version, non-marking grey	with thread guard, pressed steel, zinc-plated	with "stop-top" brake	with "ideal-stop" brake total height +17 mm	directional lock (separate) 1 x 360°	with stainless steel ball bearing in the wheel hub	with steel foot guard
Technical description page	50	116	112	112	115	84	116
Product code suffix	-ELS	-FA	-ST	-IS	RI-05.03	-XK	-FS
Available for	see series PO...-ELS (page 435)	all	all	wheel Ø 125x50, 160, 200 mm**	all***	all ball bearing wheels upon request	upon request

* **Other versions / options:** corrosion-resistant roller bearing (-XR), available for wheel Ø 125 mm (see page 84 for technical information)
 ** Synthetic adapter plate to balance out total height for swivel and fixed castors without "ideal-stop" brake: **product code AP3-17**
 *** Only for swivel castors without brake or swivel castor with "stop-top" brake upon request

LH-PO, BH-PO series

Pressed steel castors, heavy-duty design, with top plate, with nylon wheel



230–900 kg

Bracket: LH/BH series

- strong pressed steel, zinc-plated, blue-passivated, Cr6-free
- heavy fork and top plate

Swivel bracket:

- double ball bearing in the swivel head
- bolted and secured central kingpin, extremely strong
- particularly resistant to shocks and impact due to **four specially-shaped, hardened bearing seats**

Wheel: PO series

- high-quality nylon 6, impact resistant, hardness 70 Shore D, colour natural white

Additional details:

- bracket series: page 92
- brakes: page 112–113
- wheel series: page 343–344
- bearing types: page 84–85

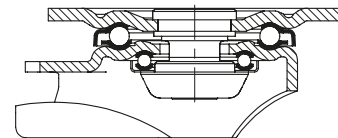

6

Swivel castors	Fixed castors	Swivel castors with "stop-fix" brake	Wheel Ø [mm]	Wheel width [mm]	Load capacity [kg]	Bearing type	Total height [mm]	Plate size [mm]	Bolt hole spacing [mm]	Bolt hole Ø [mm]	Offset swivel castor [mm]
LH-PO 82G	BH-PO 82G	LH-PO 82G-FI	80	37	230	plain bore	120	100 x 85	80 x 60	9	45
LH-PO 82K	BH-PO 82K	LH-PO 82K-FI	80	37	250	ball bearing	120	100 x 85	80 x 60	9	45
LH-PO 100G-1	BH-PO 100G-1	LH-PO 100G-1-FI	100	37	280	plain bore	140	100 x 85	80 x 60	9	45
LH-PO 100KA-1	BH-PO 100KA-1	LH-PO 100KA-1-FI	100	37	280	ball bearing (C)	140	100 x 85	80 x 60	9	45
LH-PO 100G-3	BH-PO 100G-3	LH-PO 100G-3-FI	100	37	280	plain bore	140	140 x 110	105 x 75–80	11	45
LH-PO 100KA-3	BH-PO 100KA-3	LH-PO 100KA-3-FI	100	37	280	ball bearing (C)	140	140 x 110	105 x 75–80	11	45
LH-PO 125G-1	BH-PO 125G-1	LH-PO 125G-1-FI	125	40	300	plain bore	165	100 x 85	80 x 60	9	45
LH-PO 125KA-1	BH-PO 125KA-1	LH-PO 125KA-1-FI	125	40	300	ball bearing (C)	165	100 x 85	80 x 60	9	45
LH-PO 125G-3	BH-PO 125G-3	LH-PO 125G-3-FI	125	40	300	plain bore	165	140 x 110	105 x 75–80	11	45
LH-PO 125KA-3	BH-PO 125KA-3	LH-PO 125KA-3-FI	125	40	300	ball bearing (C)	165	140 x 110	105 x 75–80	11	45
LH-PO 127K	BH-PO 127K	LH-PO 127K-FI	125	50	400	ball bearing	170	140 x 110	105 x 75–80	11	55
LH-PO 150G	BH-PO 150G	LH-PO 150G-FI	150	50	400	plain bore	197	140 x 110	105 x 75–80	11	65
LH-PO 150K	BH-PO 150K	LH-PO 150K-FI	150	50	400	ball bearing	197	140 x 110	105 x 75–80	11	65
LH-PO 160G	BH-PO 160G	LH-PO 160G-FI	160	50	450	plain bore	202	140 x 110	105 x 75–80	11	65
LH-PO 160K	BH-PO 160K	LH-PO 160K-FI	160	50	450	ball bearing	202	140 x 110	105 x 75–80	11	65
LH-PO 175G	BH-PO 175G	LH-PO 175G-FI	175	50	500	plain bore	220	140 x 110	105 x 75–80	11	67
LH-PO 175K	BH-PO 175K	LH-PO 175K-FI	175	50	500	ball bearing	220	140 x 110	105 x 75–80	11	67
LH-PO 200G	BH-PO 200G	LH-PO 200G-FI	200	50	600	plain bore	245	140 x 110	105 x 75–80	11	70
LH-PO 200K	BH-PO 200K	LH-PO 200K-FI	200	50	600	ball bearing	245	140 x 110	105 x 75–80	11	70
LH-PO 250G	BH-PO 250G	*	250	50	900	plain bore	295	140 x 110	105 x 75–80	11	82
LH-PO 250K	BH-PO 250K	*	250	50	900	ball bearing	295	140 x 110	105 x 75–80	11	82

* "stop-top" brake version, see versions / options

Versions / options**



	electrically conductive version, non-marking grey	with thread guard, pressed steel, zinc-plated	with "stop-top" brake	with "central-stop" central brake system	with "ideal-stop" brake total height +17 mm	with directional lock (separate) 1x 360°	with steel foot guard
Technical description page	50	116	112	113	112	115	116
Product code suffix	-ELS	-FA	-ST	-CS13	-IS	see ****	-FS
Available for	see series PO...-ELS (page 435)	wheel Ø 80–200 mm	all	wheel Ø 160, 200 mm	wheel Ø 160, 200 mm***	for wheel Ø and plate dimensions, see****	wheel Ø 100–250 mm

** Other versions / options: 1. stainless steel ball bearing in the wheel hub (-XK / -XKA), available upon request (technical information page 84 / 85)

*** Synthetic adapter plate to balance out total height for swivel and fixed castors without "ideal-stop" brake: **product code AP3-17**

**** **RI-04.01** for wheel Ø 80–125 mm with plate 100x85 mm, **RI-04.03** for wheel Ø 100–125x40 mm with plate 140x110 mm, **RI-05.03** for wheel Ø 125x50–200 mm (Only for swivel castors without brake or swivel castor with "stop-top" and "central-stop" brake upon request)

LUH-PO, BH-PO series

Pressed steel castors, heavy-duty design, enclosed, with top plate, with nylon wheel

400–600 kg

Bracket: LUH/BH series

- strong pressed steel, zinc-plated, blue-passivated, Cr6-free

Swivel bracket:

- four-point ball bearing for extremely heavy loads
- enclosed and sealed swivel head
- particularly resistant to shocks and impact due to **specialty-shaped, hardened bearing seats**

Wheel: PO series

- high-quality nylon 6, impact resistant, hardness 70 Shore D, colour natural white

Additional details:

- bracket series: page 93
- brakes: page 112–113
- wheel series: page 343–344
- bearing types: page 84–85

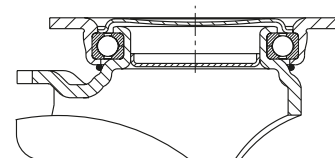

Swivel castors	Fixed castors	Swivel castors with "stop-fix" brake	Wheel Ø [mm]	Wheel width [mm]	Load capacity [kg]	Bearing type	Total height [mm]	Plate size [mm]	Bolt hole spacing [mm]	Bolt hole Ø [mm]	Offset swivel castor [mm]
LUH-PO 127K	BH-PO 127K	LUH-PO 127K-FI	125	50	400	ball bearing	170	140 x 110	105 x 75–80	11	55
LUH-PO 150G	BH-PO 150G	LUH-PO 150G-FI	150	50	400	plain bore	197	140 x 110	105 x 75–80	11	61
LUH-PO 150K	BH-PO 150K	LUH-PO 150K-FI	150	50	400	ball bearing	197	140 x 110	105 x 75–80	11	61
LUH-PO 160G	BH-PO 160G	LUH-PO 160G-FI	160	50	450	plain bore	202	140 x 110	105 x 75–80	11	61
LUH-PO 160K	BH-PO 160K	LUH-PO 160K-FI	160	50	450	ball bearing	202	140 x 110	105 x 75–80	11	61
LUH-PO 200G	BH-PO 200G	LUH-PO 200G-FI	200	50	600	plain bore	245	140 x 110	105 x 75–80	11	63
LUH-PO 200K	BH-PO 200K	LUH-PO 200K-FI	200	50	600	ball bearing	245	140 x 110	105 x 75–80	11	63

6

Versions / options



	electrically conductive version, non-marking grey	with thread guard, pressed steel, zinc-plated	directional lock (separate) 1 x 360°	with stainless steel ball bearing in the wheel hub	with steel foot guard
Technical description page	50	116	115	84	116
Product code suffix	-ELS	-FA	RI-05.03	-XK	-FS
Available for	see series PO...-ELS (page 435)	all	all*	upon request	upon request

* Only for swivel castors without brake

LO-PO, BO-PO series

Welded steel heavy-duty castors, with nylon wheel



400–1,000 kg

Bracket: LO/BO series

- solid welded steel construction, zinc-plated, blue-passivated, Cr6-free

Swivel bracket:

- double ball bearing in the swivel head
- **four specially-shaped, hardened bearing seats** for additional strength
- bolted and secured welded central kingpin, extremely strong
- swivel head seal with labyrinth design
- grease nipple

Wheel: PO series

- high-quality nylon 6, impact resistant, hardness 70 Shore D, colour natural white

Additional details:

- bracket series: page 93
- brakes: page 112–113
- wheel series: page 343–344
- bearing types: page 84–85

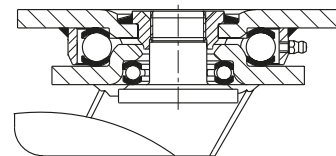

6

Swivel castors	Fixed castors	Swivel castor with "stop-top" brake	Wheel Ø [mm]	Wheel width [mm]	Load capacity [kg]	Bearing type	Total height [mm]	Plate size [mm]	Bolt hole spacing [mm]	Bolt hole Ø [mm]	Offset swivel castor [mm]
LO-PO 127K	BO-PO 127K	LO-PO 127K-ST	125	50	400	ball bearing	170	140 x 110	105 x 75–80	11	55
LO-PO 150G	BO-PO 150G	LO-PO 150G-ST	150	50	400	plain bore	200	140 x 110	105 x 75–80	11	55
LO-PO 150K	BO-PO 150K	LO-PO 150K-ST	150	50	400	ball bearing	200	140 x 110	105 x 75–80	11	55
LO-PO 160G	BO-PO 160G	LO-PO 160G-ST	160	50	450	plain bore	205	140 x 110	105 x 75–80	11	55
LO-PO 160K	BO-PO 160K	LO-PO 160K-ST	160	50	450	ball bearing	205	140 x 110	105 x 75–80	11	55
LO-PO 200G	BO-PO 200G	LO-PO 200G-ST	200	50	600	plain bore	245	140 x 110	105 x 75–80	11	60
LO-PO 200K	BO-PO 200K	LO-PO 200K-ST	200	50	600	ball bearing	245	140 x 110	105 x 75–80	11	60
LO-PO 250G	BO-PO 250G	LO-PO 250G-ST	250	50	1,000	plain bore	295	140 x 110	105 x 75–80	11	70
LO-PO 250K	BO-PO 250K	LO-PO 250K-ST	250	50	1,000	ball bearing	295	140 x 110	105 x 75–80	11	70

Versions / options



	electrically conductive version, non-marking grey	with directional lock 4 x 90°	with stainless steel ball bearing in the wheel hub	with steel foot guard	truck lock
Technical description page	50	115	84	116	114
Product code suffix	-ELS	-RI4	-XK	-FS	FF 125 / 150 / 160 / 200
Available for	see series PO...-ELS (page 435)	wheel Ø 125–200 mm	upon request	upon request	wheel Ø 125–200 mm

SPO series, wheel Ø 75–160 mm

Heavy-duty nylon wheels



300–850 kg

Tread and tyre hardness
 70 Shore D

Smooth operation / floor preservation
 satisfactory

Rolling resistance
 excellent

Wear resistance
 good

- Wheel:**
- high-quality nylon 6, impact resistant, hardness 70 Shore D
 - extremely robust heavy-duty version
 - excellent rolling and swivel resistance
 - easy operation on smooth surfaces
 - high abrasion resistance
 - colour natural white

- Other features:**
- high chemical resistance to many aggressive substances
 - operating temperature: -20 °C to +80 °C, reduced load capacity over +35 °C

- Additional details:**
- wheel series: page 69
 - tread: page 57
 - bearing types: page 84–85
 - chemical resistance: page 51

Wheels	Wheel Ø	Wheel width	Load capacity	Bearing type	Axle bore Ø	Hub length
	(D) [mm]	(T2) [mm]	[kg]		(d) [mm]	(T1) [mm]
SPO 75/12G	75	32	300	plain bore	12	35
SPO 75/15-45G	75	32	300	plain bore	15	45
SPO 75/15G	75	32	300	plain bore	15	35
SPO 75/15K	75	32	300	ball bearing	15	35
SPO 80/15G	80	37	350	plain bore	15	45
SPO 80/15K	80	37	350	ball bearing	15	45
SPO 82/20K	80	70	650	ball bearing	20	70
SPO 100/15G	100	37	500	plain bore	15	45
SPO 100/15K	100	37	500	ball bearing	15	45
SPO 125/15G	125	40	700	plain bore	15	45
SPO 125/20G	125	40	700	plain bore	20	45
SPO 125/15K	125	40	700	ball bearing	15	45
SPO 125/20K	125	40	700	ball bearing	20	45
SPO 127/20G	125	50	750	plain bore	20	60
SPO 127/20K	125	50	750	ball bearing	20	60
SPO 150/20G	150	50	800	plain bore	20	60
SPO 150/20K	150	50	800	ball bearing	20	60
SPO 150/25K	150	50	800	ball bearing	25	60
SPO 160/20G	160	50	850	plain bore	20	60
SPO 160/20K	160	50	850	ball bearing	20	60
SPO 160/25K	160	50	850	ball bearing	25	60

For other wheel Ø, see next page

Versions / options



	with grease nipple	with stainless steel ball bearing in the wheel hub
Technical description page		84
Product code suffix	-NI	-XK
Available for	upon request	upon request*

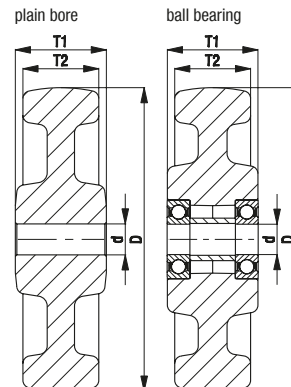

* Some dimensions may result in reduced load capacities

SPO series, wheel Ø 175–250 mm

Heavy-duty nylon wheels



1,000–2,000 kg

Tread and tyre hardness
 70 Shore D

Smooth operation / floor preservation
 satisfactory

Rolling resistance
 excellent

Wear resistance
 good

- Wheel:**
- high-quality nylon 6, impact resistant, hardness 70 Shore D
 - extremely robust heavy-duty version
 - excellent rolling and swivel resistance
 - easy operation on smooth surfaces
 - high abrasion resistance
 - colour natural white

- Other features:**
- high chemical resistance to many aggressive substances
 - operating temperature: -20 °C to +80 °C, reduced load capacity over +35 °C

- Additional details:**
- wheel series: page 69
 - tread: page 57
 - bearing types: page 84–85
 - chemical resistance: page 51

Wheels	Wheel Ø (D) [mm]	Wheel width (T2) [mm]	Load capacity [kg]	Bearing type	Axle bore Ø (d) [mm]	Hub length (T1) [mm]
SPO 175/20G	175	50	1,000	plain bore	20	60
SPO 175/20K	175	50	1,000	ball bearing	20	60
SPO 175/25K	175	50	1,000	ball bearing	25	60
SPO 201/20G	200	50	1,000	plain bore	20	60
SPO 200/20G *	200	50	1,500	plain bore	20	60
SPO 200/25G *	200	50	1,500	plain bore	25	60
SPO 201/20K	200	50	1,000	ball bearing	20	60
SPO 200/20K *	200	50	1,250	ball bearing	20	60
SPO 200/25K *	200	50	1,500	ball bearing	25	60
SPO 200/30K *	200	50	1,500	ball bearing	30	60
SPO 251/25G	250	50	1,500	plain bore	25	60
SPO 251/25K	250	50	1,500	ball bearing	25	60
SPO 250/25G **	250	65	2,000	plain bore	25	70
SPO 250/25K *	250	65	2,000	ball bearing	25	65
SPO 250/30K *	250	65	2,000	ball bearing	30	65
SPO 250/35K *	250	65	2,000	ball bearing	35	65

* Extra heavy-duty version

** Load capacity test in compliance with DIN 12532 with extended breaks to avoid thermal overloading

6

Versions / options



	with grease nipple	with stainless steel ball bearing in the wheel hub
Technical description page		84
Product code suffix	-NI	-XK
Available for	upon request	upon request***

*** Some dimensions may result in reduced load capacities

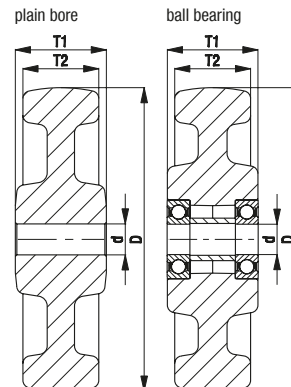

LK-SPO, BK-SPO series, wheel Ø 75–125x40 mm

Pressed steel castors, heavy-duty design, with top plate, with heavy-duty nylon wheel



300–350 kg

Bracket: LK/BK series

- strong pressed steel, zinc-plated, blue-passivated, Cr6-free

Swivel bracket:

- double ball bearing in the swivel head
- swivel head seal
- minimum swivel head play and smooth rolling characteristic and increased service life due to the special dynamic Blickle riveting process

Wheel: SPO series

- high-quality nylon 6, impact resistant, hardness 70 Shore D, extremely robust heavy-duty version, colour natural white

Additional details:

- bracket series: page 92
- brakes: page 112–113
- wheel series: page 355–356
- bearing types: page 84–85

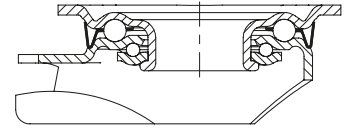

Swivel castors	Fixed castors	Swivel castors with "stop-fix" brake	Wheel Ø [mm]	Wheel width [mm]	Load capacity [kg]	Bearing type	Total height [mm]	Plate size [mm]	Bolt hole spacing [mm]	Bolt hole Ø [mm]	Offset swivel castor [mm]
LK-SPO 75G	BK-SPO 75G	LK-SPO 75G-FI	75	32	300	plain bore	108	100 x 85	80 x 60	9	40
LK-SPO 75K	BK-SPO 75K	LK-SPO 75K-FI	75	32	300	ball bearing	108	100 x 85	80 x 60	9	40
LK-SPO 80G	BK-SPO 80G	LK-SPO 80G-FI	80	37	350	plain bore	110	100 x 85	80 x 60	9	40
LK-SPO 80K	BK-SPO 80K	LK-SPO 80K-FI	80	37	350	ball bearing	110	100 x 85	80 x 60	9	40
LK-SPO 100G-1	BK-SPO 100G-1	LK-SPO 100G-1-FI	100	37	350	plain bore	130	100 x 85	80 x 60	9	45
LK-SPO 100K-1	BK-SPO 100K-1	LK-SPO 100K-1-FI	100	37	350	ball bearing	130	100 x 85	80 x 60	9	45
LK-SPO 100G-3	BK-SPO 100G-3	LK-SPO 100G-3-FI	100	37	350	plain bore	130	140 x 110	105 x 75–80	11	45
LK-SPO 100K-3	BK-SPO 100K-3	LK-SPO 100K-3-FI	100	37	350	ball bearing	130	140 x 110	105 x 75–80	11	45
LK-SPO 125G-1	BK-SPO 125G-1	LK-SPO 125G-1-FI	125	40	350	plain bore	155	100 x 85	80 x 60	9	48
LK-SPO 125K-1	BK-SPO 125K-1	LK-SPO 125K-1-FI	125	40	350	ball bearing	155	100 x 85	80 x 60	9	48
LK-SPO 125G-3	BK-SPO 125G-3	LK-SPO 125G-3-FI	125	40	350	plain bore	155	140 x 110	105 x 75–80	11	48
LK-SPO 125K-3	BK-SPO 125K-3	LK-SPO 125K-3-FI	125	40	350	ball bearing	155	140 x 110	105 x 75–80	11	48

For other wheel Ø, see next page
For stainless steel versions, see page 421

Versions / options



	with thread guard, pressed steel, zinc-plated	with "stop-top" brake	with "ideal-stop" brake total height +17 mm	with directional lock (separate) 1x 360°	with stainless steel ball bearing in the wheel hub
Technical description page	116	112	112	115	84
Product code suffix	-FA	-ST	-IS	see **	-XK
Available for	all	all	wheel Ø 125 mm with plate 140x110 mm*	for wheel Ø and plate dimensions, see**	upon request***

* Synthetic adapter plate to balance out total height for swivel and fixed castors without "ideal-stop" brake: **product code AP3-17**

** **RI-05.01** for wheel Ø 75–125 mm with plate 100x85 mm, **RI-03.03** for wheel Ø 100–125 mm with plate 140x110 mm (Only for swivel castors without brake or swivel castor with "stop-top" brake upon request)

*** Some dimensions may result in reduced load capacities

LK-SPO, BH-SPO series, wheel Ø 125x50–200 mm

Pressed steel castors, heavy-duty design, with top plate, with heavy-duty nylon wheel



600 kg

Bracket: LK/BH series

- strong pressed steel, zinc-plated, blue-passivated, Cr6-free

Swivel bracket:

- double ball bearing in the swivel head
- strong central kingpin
- swivel head seal
- minimum swivel head play and smooth rolling characteristic and increased service life due to the special dynamic Blickle riveting process

Wheel: SPO series

- high-quality nylon 6, impact resistant, hardness 70 Shore D, extremely robust heavy-duty version, colour natural white

Additional details:

- bracket series: page 92
- brakes: page 112–113
- wheel series: page 355–356
- bearing types: page 84–85

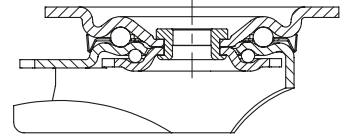

6

Swivel castors	Fixed castors	Swivel castors with "stop-fix" brake	Wheel Ø [mm]	Wheel width [mm]	Load capacity [kg]	Bearing type	Total height [mm]	Plate size [mm]	Bolt hole spacing [mm]	Bolt hole Ø [mm]	Offset swivel castor [mm]
LK-SPO 127G	BH-SPO 127G	LK-SPO 127G-FI	125	50	600	plain bore	170	140 x 110	105 x 75–80	11	55
LK-SPO 127K	BH-SPO 127K	LK-SPO 127K-FI	125	50	600	ball bearing	170	140 x 110	105 x 75–80	11	55
LK-SPO 150G	BH-SPO 150G	LK-SPO 150G-FI	150	50	600	plain bore	197	140 x 110	105 x 75–80	11	60
LK-SPO 150K	BH-SPO 150K	LK-SPO 150K-FI	150	50	600	ball bearing	197	140 x 110	105 x 75–80	11	60
LK-SPO 160G	BH-SPO 160G	LK-SPO 160G-FI	160	50	600	plain bore	202	140 x 110	105 x 75–80	11	60
LK-SPO 160K	BH-SPO 160K	LK-SPO 160K-FI	160	50	600	ball bearing	202	140 x 110	105 x 75–80	11	60
LK-SPO 175G	BH-SPO 175G	LK-SPO 175G-FI	175	50	600	plain bore	220	140 x 110	105 x 75–80	11	65
LK-SPO 175K	BH-SPO 175K	LK-SPO 175K-FI	175	50	600	ball bearing	220	140 x 110	105 x 75–80	11	65
LK-SPO 200G *	BH-SPO 200G *	LK-SPO 200G-FI *	200	50	600	plain bore	245	140 x 110	105 x 75–80	11	62
LK-SPO 201G	BH-SPO 201G	LK-SPO 201G-FI	200	50	600	plain bore	245	140 x 110	105 x 75–80	11	62
LK-SPO 200K *	BH-SPO 200K *	LK-SPO 200K-FI *	200	50	600	ball bearing	245	140 x 110	105 x 75–80	11	62
LK-SPO 201K	BH-SPO 201K	LK-SPO 201K-FI	200	50	600	ball bearing	245	140 x 110	105 x 75–80	11	62

* Extra heavy-duty wheel design

For stainless steel versions, see page 421

Versions / options



	with thread guard, pressed steel, zinc-plated	with "stop-top" brake	with "ideal-stop" brake total height +17 mm	directional lock (separate) 1 x 360°	with stainless steel ball bearing in the wheel hub	with steel foot guard
Technical description page	116	112	112	115	84	116
Product code suffix	-FA	-ST	-IS	RI-05.03	-XK	-FS
Available for	all	all	wheel Ø 125, 160, 200 mm**	all***	upon request****	upon request

** Synthetic adapter plate to balance out total height for swivel and fixed castors without "ideal-stop" brake: product code AP3-17

*** Only for swivel castors without brake or swivel castor with "stop-top" brake upon request

**** Some dimensions may result in reduced load capacities

LKR-SPO series

**Pressed steel castors, heavy-duty design,
with bolt hole,
with heavy-duty nylon wheel**



300–350 kg

Bracket: LKR series

- strong pressed steel, zinc-plated, blue-passivated, Cr6-free
- double ball bearing in the swivel head
- strong central kingpin
- minimum swivel head play and smooth rolling characteristic and increased service life due to the special dynamic Blickle riveting process

Wheel: SPO series

- high-quality nylon 6, impact resistant, hardness 70 Shore D, extremely robust heavy-duty version, colour natural white

Additional details:

- bracket series: page 92
- brakes: page 112–113
- wheel series: page 355–356
- bearing types: page 84–85

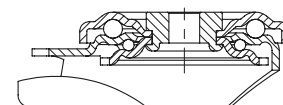

6

Swivel castors	Swivel castors with "stop-fix" brake	Wheel Ø [mm]	Wheel width [mm]	Load capacity [kg]	Bearing type	Total height [mm]	Plate Ø [mm]	Bolt hole Ø [mm]	Offset swivel castor [mm]
LKR-SPO 75G	LKR-SPO 75G-FI	75	32	300	plain bore	108	88	13	40
LKR-SPO 75K	LKR-SPO 75K-FI	75	32	300	ball bearing	108	88	13	40
LKR-SPO 80G	LKR-SPO 80G-FI	80	37	350	plain bore	110	88	13	40
LKR-SPO 80K	LKR-SPO 80K-FI	80	37	350	ball bearing	110	88	13	40
LKR-SPO 100G	LKR-SPO 100G-FI	100	37	350	plain bore	130	88	13	45
LKR-SPO 100K	LKR-SPO 100K-FI	100	37	350	ball bearing	130	88	13	45
LKR-SPO 125G	LKR-SPO 125G-FI	125	40	350	plain bore	155	88	13	48
LKR-SPO 125K	LKR-SPO 125K-FI	125	40	350	ball bearing	155	88	13	48

Versions / options



	with thread guard, pressed steel, zinc-plated	with stainless steel ball bearing in the wheel hub	truck lock
Technical description page	116	84	114
Product code suffix	-FA	-XK	FF 100-1 / FF 125-1
Available for	all	upon request*	wheel Ø 100+125 mm

* Some dimensions may result in reduced load capacities

LH-SPO, BH-SPO series, wheel Ø 75–125 mm

Pressed steel castors, heavy-duty design, with top plate, with heavy-duty nylon wheel



300–750 kg

Bracket: LH/BH series

- strong pressed steel, zinc-plated, blue-passivated, Cr6-free
- heavy fork and top plate

Swivel bracket:

- double ball bearing in the swivel head
- bolted and secured central kingpin, extremely strong
- particularly resistant to shocks and impact due to **four specially-shaped, hardened bearing seats**

Wheel: SPO series

- high-quality nylon 6, impact resistant, hardness 70 Shore D, extremely robust heavy-duty version, colour natural white

Additional details:

- bracket series: page 92
- brakes: page 112–113
- wheel series: page 355
- bearing types: page 84–85

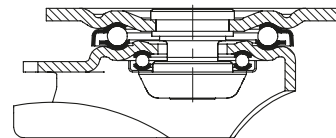

6

Swivel castors	Fixed castors	Swivel castors with "stop-fix" brake	Wheel Ø [mm]	Wheel width [mm]	Load capacity [kg]	Bearing type	Total height [mm]	Plate size [mm]	Bolt hole spacing [mm]	Bolt hole Ø [mm]	Offset swivel castor [mm]
LH-SPO 75G	BH-SPO 75G	LH-SPO 75G-FI	75	32	300	plain bore	118	100 x 85	80 x 60	9	45
LH-SPO 75K	BH-SPO 75K	LH-SPO 75K-FI	75	32	300	ball bearing	118	100 x 85	80 x 60	9	45
LH-SPO 80G	BH-SPO 80G	LH-SPO 80G-FI	80	37	350	plain bore	120	100 x 85	80 x 60	9	45
LH-SPO 80K	BH-SPO 80K	LH-SPO 80K-FI	80	37	350	ball bearing	120	100 x 85	80 x 60	9	45
LH-SPO 82K			80	70	650	ball bearing	112	100 x 85	80 x 60	9	45
LH-SPO 100G-1	BH-SPO 100G-1	LH-SPO 100G-1-FI	100	37	500	plain bore	140	100 x 85	80 x 60	9	45
LH-SPO 100K-1	BH-SPO 100K-1	LH-SPO 100K-1-FI	100	37	500	ball bearing	140	100 x 85	80 x 60	9	45
LH-SPO 100G-3	BH-SPO 100G-3	LH-SPO 100G-3-FI	100	37	500	plain bore	140	140 x 110	105 x 75–80	11	45
LH-SPO 100K-3	BH-SPO 100K-3	LH-SPO 100K-3-FI	100	37	500	ball bearing	140	140 x 110	105 x 75–80	11	45
LH-SPO 125G-1	BH-SPO 125G-1	LH-SPO 125G-1-FI	125	40	700	plain bore	165	100 x 85	80 x 60	9	45
LH-SPO 125K-1	BH-SPO 125K-1	LH-SPO 125K-1-FI	125	40	700	ball bearing	165	100 x 85	80 x 60	9	45
LH-SPO 125G-3	BH-SPO 125G-3	LH-SPO 125G-3-FI	125	40	700	plain bore	165	140 x 110	105 x 75–80	11	45
LH-SPO 125K-3	BH-SPO 125K-3	LH-SPO 125K-3-FI	125	40	700	ball bearing	165	140 x 110	105 x 75–80	11	45
LH-SPO 127G	BH-SPO 127G	LH-SPO 127G-FI	125	50	750	plain bore	170	140 x 110	105 x 75–80	11	55
LH-SPO 127K	BH-SPO 127K	LH-SPO 127K-FI	125	50	750	ball bearing	170	140 x 110	105 x 75–80	11	55

For other wheel Ø, see next page

Versions / options



	with thread guard, pressed steel, zinc-plated	with "stop-top" brake	with directional lock (separate) 1x 360°	with stainless steel ball bearing in the wheel hub	with steel foot guard
Technical description page	116	112	115	84	116
Product code suffix	-FA	-ST	see *	-XK	-FS
Available for	all with exception of wheel Ø 80x70 mm	all with exception of wheel Ø 80x70 mm	for wheel Ø and plate dimensions, see*	upon request**	all from wheel Ø 100 mm

* RI-04.01 for wheel Ø 75, 80x37, 100, 125 mm with plate 100x85 mm, RI-04.03 for wheel Ø 100, 125x40 mm with plate 140x110 mm, RI-05.03 for wheel Ø 125x50 mm (Only for swivel castors without brake or swivel castor with "stop-top" brake upon request)

** Some dimensions may result in reduced load capacities

LH-SPO, BH-SPO series, wheel Ø 150–250 mm

Pressed steel castors, heavy-duty design, with top plate, with heavy-duty nylon wheel



800–900 kg

Bracket: LH/BH series

- strong pressed steel, zinc-plated, blue-passivated, Cr6-free
- heavy fork and top plate

Swivel bracket:

- double ball bearing in the swivel head
- bolted and secured central kingpin, extremely strong
- particularly resistant to shocks and impact due to **four specially-shaped, hardened bearing seats**

Wheel: SPO series

- high-quality nylon 6, impact resistant, hardness 70 Shore D, extremely robust heavy-duty version, colour natural white

Additional details:

- bracket series: page 92
- brakes: page 112–113
- wheel series: page 355–356
- bearing types: page 84–85

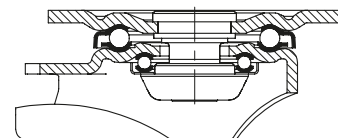

Swivel castors	Fixed castors	Swivel castors with "stop-fix" brake	Wheel Ø [mm]	Wheel width [mm]	Load capacity [kg]	Bearing type	Total height [mm]	Plate size [mm]	Bolt hole spacing [mm]	Bolt hole Ø [mm]	Offset swivel castor [mm]
LH-SPO 150G	BH-SPO 150G	LH-SPO 150G-FI	150	50	800	plain bore	197	140 x 110	105 x 75–80	11	65
LH-SPO 150K	BH-SPO 150K	LH-SPO 150K-FI	150	50	800	ball bearing	197	140 x 110	105 x 75–80	11	65
LH-SPO 160G	BH-SPO 160G	LH-SPO 160G-FI	160	50	850	plain bore	202	140 x 110	105 x 75–80	11	65
LH-SPO 160K	BH-SPO 160K	LH-SPO 160K-FI	160	50	850	ball bearing	202	140 x 110	105 x 75–80	11	65
LH-SPO 175G	BH-SPO 175G	LH-SPO 175G-FI	175	50	900	plain bore	220	140 x 110	105 x 75–80	11	67
LH-SPO 175K	BH-SPO 175K	LH-SPO 175K-FI	175	50	900	ball bearing	220	140 x 110	105 x 75–80	11	67
LH-SPO 200G *	BH-SPO 200G *	LH-SPO 200G-FI *	200	50	900	plain bore	245	140 x 110	105 x 75–80	11	70
LH-SPO 201G	BH-SPO 201G	LH-SPO 201G-FI	200	50	900	plain bore	245	140 x 110	105 x 75–80	11	70
LH-SPO 200K *	BH-SPO 200K *	LH-SPO 200K-FI *	200	50	900	ball bearing	245	140 x 110	105 x 75–80	11	70
LH-SPO 201K	BH-SPO 201K	LH-SPO 201K-FI	200	50	900	ball bearing	245	140 x 110	105 x 75–80	11	70
LH-SPO 251G	BH-SPO 251G	**	250	50	900	plain bore	295	140 x 110	105 x 75–80	11	82
LH-SPO 251K	BH-SPO 251K	**	250	50	900	ball bearing	295	140 x 110	105 x 75–80	11	82
LH-SPO 250G *	BH-SPO 250G *	**	250	65	900	plain bore	295	140 x 110	105 x 75–80	11	82
LH-SPO 250K *	BH-SPO 250K *	**	250	65	900	ball bearing	295	140 x 110	105 x 75–80	11	82

* Extra heavy-duty wheel design

** "stop-top" brake version, see versions / options

Versions / options



	with thread guard, pressed steel, zinc-plated	with "stop-top" brake	with "central-stop" central brake system	with "ideal-stop" brake total height +17 mm	directional lock (separate) 1 x 360°	with steel foot guard	with stainless steel ball bearing in the wheel hub
Technical description page	116	112	113	112	115	116	84
Product code suffix	-FA	-ST	-CS13	-IS	RI-05.03	-FS	-XK
Available for	wheel Ø 150–200 mm	all	wheel Ø 160+200 mm	wheel Ø 160+200 mm***	wheel Ø 150–200 mm****	all	upon request*****

*** Synthetic adapter plate to balance out total height for swivel and fixed castors without "ideal-stop" brake: **product code AP3-17**

**** Only for swivel castors without brake or swivel castor with "stop-top" and "central-stop" brake upon request

***** Some dimensions may result in reduced load capacities

LHZ-SPO series

Pressed steel castors, heavy-duty design, with stem, with heavy-duty nylon wheel



750–900 kg

Bracket: LHZ series

- strong pressed steel, zinc-plated, blue-passivated, Cr6-free
- heavy fork and top plate
- double ball bearing in the swivel head
- very strong, welded steel plug-in stem, bolted and secured
- particularly resistant to shocks and impact due to **four specially-shaped, hardened bearing seats**

Wheel: SPO series

- high-quality nylon 6, impact resistant, hardness 70 Shore D, extremely robust heavy-duty version, colour natural white

Additional details:

- bracket series: page 92
- brakes: page 112–113
- wheel series: page 355–356
- bearing types: page 84–85

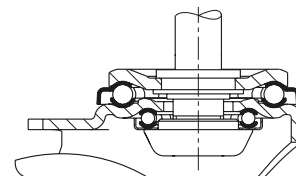

6

Swivel castors	Swivel castors with "stop-fix" brake	Wheel Ø [mm]	Wheel width [mm]	Load capacity [kg]	Bearing type	Total height [mm]	Stem Ø [mm]	Stem length [mm]	Offset swivel castor [mm]
LHZ-SPO 127G	LHZ-SPO 127G-FI	125	50	750	plain bore	170	27	60	55
LHZ-SPO 127K	LHZ-SPO 127K-FI	125	50	750	ball bearing	170	27	60	55
LHZ-SPO 150G	LHZ-SPO 150G-FI	150	50	800	plain bore	197	27	60	65
LHZ-SPO 150K	LHZ-SPO 150K-FI	150	50	800	ball bearing	197	27	60	65
LHZ-SPO 160G	LHZ-SPO 160G-FI	160	50	850	plain bore	202	27	60	65
LHZ-SPO 160K	LHZ-SPO 160K-FI	160	50	850	ball bearing	202	27	60	65
LHZ-SPO 200G *	LHZ-SPO 200G-FI *	200	50	900	plain bore	245	27	60	70
LHZ-SPO 201G	LHZ-SPO 201G-FI	200	50	900	plain bore	245	27	60	70
LHZ-SPO 200K *	LHZ-SPO 200K-FI *	200	50	900	ball bearing	245	27	60	70
LHZ-SPO 201K	LHZ-SPO 201K-FI	200	50	900	ball bearing	245	27	60	70

* Extra heavy-duty wheel design

Versions / options

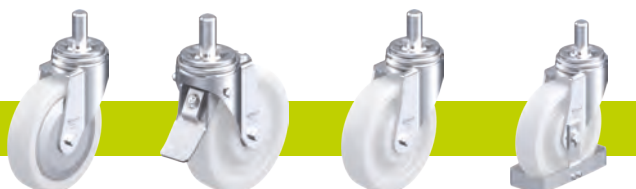

	with thread guard, pressed steel, zinc-plated	with "stop-top" brake	with stainless steel ball bearing in the wheel hub	with steel foot guard
Technical description page	116	112	84	116
Product code suffix	-FA	-ST	-XK	-FS
Available for	all	all	upon request**	upon request

** Some dimensions may result in reduced load capacities

LUH-SPO, BH-SPO series

Pressed steel castors, heavy-duty design, enclosed, with top plate, with heavy-duty nylon wheel

750–1,000 kg

Bracket: LUH/BH series

- strong pressed steel, zinc-plated, blue-passivated, Cr6-free

Swivel bracket:

- four-point ball bearing for extremely heavy loads
- enclosed and sealed swivel head
- particularly resistant to shocks and impact due to **specially-shaped, hardened bearing seats**

Wheel: SPO series

- high-quality nylon 6, impact resistant, hardness 70 Shore D, extremely robust heavy-duty version, colour natural white

Additional details:

- bracket series: page 93
- brakes: page 112–113
- wheel series: page 355–356
- bearing types: page 84–85

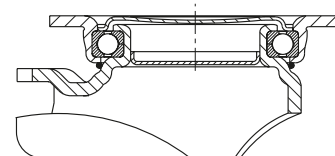

Swivel castors	Fixed castors	Swivel castors with "stop-fix" brake	Wheel Ø [mm]	Wheel width [mm]	Load capacity [kg]	Bearing type	Total height [mm]	Plate size [mm]	Bolt hole spacing [mm]	Bolt hole Ø [mm]	Offset swivel castor [mm]
LUH-SPO 127G	BH-SPO 127G	LUH-SPO 127G-FI	125	50	750	plain bore	170	140 x 110	105 x 75–80	11	55
LUH-SPO 127K	BH-SPO 127K	LUH-SPO 127K-FI	125	50	750	ball bearing	170	140 x 110	105 x 75–80	11	55
LUH-SPO 150G	BH-SPO 150G	LUH-SPO 150G-FI	150	50	800	plain bore	197	140 x 110	105 x 75–80	11	61
LUH-SPO 150K	BH-SPO 150K	LUH-SPO 150K-FI	150	50	800	ball bearing	197	140 x 110	105 x 75–80	11	61
LUH-SPO 160G	BH-SPO 160G	LUH-SPO 160G-FI	160	50	850	plain bore	202	140 x 110	105 x 75–80	11	61
LUH-SPO 160K	BH-SPO 160K	LUH-SPO 160K-FI	160	50	850	ball bearing	202	140 x 110	105 x 75–80	11	61
LUH-SPO 200G *	BH-SPO 200G *	LUH-SPO 200G-FI *	200	50	1,000	plain bore	245	140 x 110	105 x 75–80	11	63
LUH-SPO 201G	BH-SPO 201G	LUH-SPO 201G-FI	200	50	1,000	plain bore	245	140 x 110	105 x 75–80	11	63
LUH-SPO 200K *	BH-SPO 200K *	LUH-SPO 200K-FI *	200	50	1,000	ball bearing	245	140 x 110	105 x 75–80	11	63
LUH-SPO 201K	BH-SPO 201K	LUH-SPO 201K-FI	200	50	1,000	ball bearing	245	140 x 110	105 x 75–80	11	63

* Extra heavy-duty wheel design

Versions / options



	with thread guard, pressed steel, zinc-plated	directional lock (separate) 1 x 360°	with stainless steel ball bearing in the wheel hub	with steel foot guard
Technical description page	116	115	84	116
Product code suffix	-FA	RI-05.03	-XK	-FS
Available for	all	all**	upon request***	upon request

** Only for swivel castors without brake

*** Some dimensions may result in reduced load capacities

LO-SPO, BO-SPO series

Welded steel heavy-duty castors, with heavy-duty nylon wheel



750–1,250 kg

Bracket: LO/BO series

- solid welded steel construction, zinc-plated, blue-passivated, Cr6-free

Swivel bracket:

- double ball bearing in the swivel head
- **four specially-shaped, hardened bearing seats** for additional strength
- bolted and secured welded central kingpin, extremely strong
- swivel head seal with labyrinth design
- grease nipple

Wheel: SPO series

- high-quality nylon 6, impact resistant, hardness 70 Shore D, extremely robust heavy-duty version, colour natural white

Additional details:

- bracket series: page 93
- brakes: page 112–113
- wheel series: page 355–356
- bearing types: page 84–85

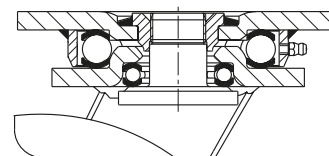

6

Swivel castors	Fixed castors	Swivel castor with "stop-top" brake	Wheel Ø [mm]	Wheel width [mm]	Load capacity [kg]	Bearing type	Total height [mm]	Plate size [mm]	Bolt hole spacing [mm]	Bolt hole Ø [mm]	Offset swivel castor [mm]
LO-SPO 127G	BO-SPO 127G	LO-SPO 127G-ST	125	50	750	plain bore	170	140 x 110	105 x 75–80	11	50
LO-SPO 127K	BO-SPO 127K	LO-SPO 127K-ST	125	50	750	ball bearing	170	140 x 110	105 x 75–80	11	50
LO-SPO 150G	BO-SPO 150G	LO-SPO 150G-ST	150	50	800	plain bore	200	140 x 110	105 x 75–80	11	55
LO-SPO 150K	BO-SPO 150K	LO-SPO 150K-ST	150	50	800	ball bearing	200	140 x 110	105 x 75–80	11	55
LO-SPO 160G	BO-SPO 160G	LO-SPO 160G-ST	160	50	850	plain bore	205	140 x 110	105 x 75–80	11	55
LO-SPO 160K	BO-SPO 160K	LO-SPO 160K-ST	160	50	850	ball bearing	205	140 x 110	105 x 75–80	11	55
LO-SPO 201G	BO-SPO 201G	LO-SPO 201G-ST	200	50	1,000	plain bore	245	140 x 110	105 x 75–80	11	60
LO-SPO 200G *	BO-SPO 200G *	LO-SPO 200G-ST *	200	50	1,250	plain bore	245	140 x 110	105 x 75–80	11	60
LO-SPO 201K	BO-SPO 201K	LO-SPO 201K-ST	200	50	1,000	ball bearing	245	140 x 110	105 x 75–80	11	60
LO-SPO 200K *	BO-SPO 200K *	LO-SPO 200K-ST *	200	50	1,250	ball bearing	245	140 x 110	105 x 75–80	11	60
LO-SPO 251G	BO-SPO 251G	LO-SPO 251G-ST	250	50	1,200	plain bore	295	140 x 110	105 x 75–80	11	70
LO-SPO 251K	BO-SPO 251K	LO-SPO 251K-ST	250	50	1,200	ball bearing	295	140 x 110	105 x 75–80	11	70
LO-SPO 250G *	BO-SPO 250G *	LO-SPO 250G-ST *	250	65	1,200	plain bore	295	140 x 110	105 x 75–80	11	70
LO-SPO 250K *	BO-SPO 250K *	LO-SPO 250K-ST *	250	65	1,200	ball bearing	295	140 x 110	105 x 75–80	11	70

* Extra heavy-duty wheel design

Versions / options



	with directional lock 4 x 90°	with stainless steel ball bearing in the wheel hub	with steel foot guard	truck lock
Technical description page	115	84	116	114
Product code suffix	-RI4	-XK	-FS	FF 125 / 150 / 160 / 200
Available for	wheel Ø 125–200 mm	upon request**	upon request	wheel Ø 125–200 mm

** Some dimensions may result in reduced load capacities

LS-SPO, BS-SPO series

**Welded steel heavy-duty castors,
heavy-duty swivel head,
with heavy-duty nylon wheel**

750–2,000 kg

Bracket: LS/BS series

- particularly robust welded steel construction, zinc-plated, yellow-passivated, Cr6-free
- Swivel bracket:
 - axial grooved ball bearing ISO 104 and tapered roller bearing ISO 355 in the swivel head
 - bolted and secured welded central kingpin, extremely strong
 - dust and splash-proof
 - grease nipple

Wheel: SPO series

- high-quality nylon 6, impact resistant, hardness 70 Shore D, extremely robust heavy-duty version, colour natural white

Additional details:

- bracket series: page 94
- brakes: page 112–113
- wheel series: page 355–356
- bearing types: page 84–85

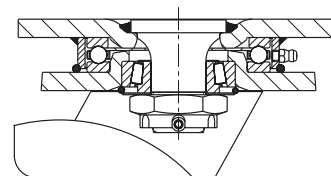

Swivel castors	Fixed castors	Swivel castor with "stop-top" brake	Wheel Ø [mm]	Wheel width [mm]	Load capacity [kg]	Bearing type	Total height [mm]	Plate size [mm]	Bolt hole spacing [mm]	Bolt hole Ø [mm]	Offset swivel castor [mm]
LS-SPO 127G	BS-SPO 127G	LS-SPO 127G-ST	125	50	750	plain bore	170	140 x 110	105 x 75–80	11	50
LS-SPO 127K	BS-SPO 127K	LS-SPO 127K-ST	125	50	750	ball bearing	170	140 x 110	105 x 75–80	11	50
LS-SPO 150G	BS-SPO 150G	LS-SPO 150G-ST	150	50	800	plain bore	200	140 x 110	105 x 75–80	11	55
LS-SPO 150K	BS-SPO 150K	LS-SPO 150K-ST	150	50	800	ball bearing	200	140 x 110	105 x 75–80	11	55
LS-SPO 160G	BS-SPO 160G	LS-SPO 160G-ST	160	50	850	plain bore	205	140 x 110	105 x 75–80	11	55
LS-SPO 160K	BS-SPO 160K	LS-SPO 160K-ST	160	50	850	ball bearing	205	140 x 110	105 x 75–80	11	55
LS-SPO 200G *	BS-SPO 200G *	LS-SPO 200G-ST *	200	50	1,500	plain bore	245	140 x 110	105 x 75–80	11	60
LS-SPO 200K *	BS-SPO 200K *	LS-SPO 200K-ST *	200	50	1,500	ball bearing	245	140 x 110	105 x 75–80	11	60
LS-SPO 251G	BS-SPO 251G	LS-SPO 251G-ST	250	50	1,500	plain bore	305	175 x 140	140 x 105	14	75
LS-SPO 251K	BS-SPO 251K	LS-SPO 251K-ST	250	50	1,500	ball bearing	305	175 x 140	140 x 105	14	75
LS-SPO 250G *	BS-SPO 250G *	LS-SPO 250G-ST *	250	65	2,000	plain bore	305	175 x 140	140 x 105	14	75
LS-SPO 250K *	BS-SPO 250K *	LS-SPO 250K-ST *	250	65	2,000	ball bearing	305	175 x 140	140 x 105	14	75

* Extra heavy-duty wheel design

Versions / options



	with thread guard, pressed steel, zinc-plated	with directional lock 4 x 90°	with stainless steel ball bearing in the wheel hub	with steel foot guard	with spring-loaded foot guard	truck lock
Technical description page	116	115	84	116	116	114
Product code suffix	-FA	-RI4	-XK	-FS	-FG	FF 125 / 150 / 160 / 200
Available for	wheel Ø 125–200 mm	all	upon request**	all	upon request	wheel Ø 125–200 mm

** Some dimensions may result in reduced load capacities

LOD-SPO, BOD-SPO series

Welded steel twin wheel heavy-duty castors, with heavy-duty nylon wheels



630–1,200 kg

Bracket: LOD/BOD series

- solid welded steel construction, zinc-plated, blue-passivated, Cr6-free

Swivel bracket:

- double ball bearing in the swivel head
- **four specially-shaped, hardened bearing seats** for additional strength
- bolted and secured welded central kingpin, extremely strong
- swivel head seal with labyrinth design
- grease nipple

Wheel: SPO series

- high-quality nylon 6, impact resistant, hardness 70 Shore D, extremely robust heavy-duty version, colour natural white

Additional details:

- bracket series: page 93
- wheel series: page 355–356
- bearing types: page 84–85

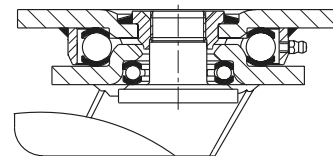

6

Swivel castors	Fixed castors	Wheel Ø [mm]	Wheel width [mm]	Load capacity [kg]	Bearing type	Total height [mm]	Plate size [mm]	Bolt hole spacing [mm]	Bolt hole Ø [mm]	Offset swivel castor [mm]
LOD-SPO 80K	BOD-SPO 80K	80	2 x 37	630	ball bearing	125	140 x 110	105 x 75–80	11	40
LOD-SPO 100K	BOD-SPO 100K	100	2 x 37	900	ball bearing	145	140 x 110	105 x 75–80	11	45
LOD-SPO 125K	BOD-SPO 125K	125	2 x 40	1,200	ball bearing	170	140 x 110	105 x 75–80	11	50

Fixed castors: long side of plate parallel to the wheel axle

LSD-SPO, BSD-SPO series

Welded steel heavy-duty twin wheel castors, heavy-duty swivel head, with heavy-duty nylon wheels

1,350–3,600 kg

Bracket: LSD/BSL series

- particularly robust welded steel construction, zinc-plated, yellow-passivated, Cr6-free

Swivel bracket:

- axial grooved ball bearing ISO 104 and tapered roller bearing ISO 355 in the swivel head
- bolted and secured welded central kingpin, extremely strong
- dust and splash-proof
- grease nipple

Wheel: SPO series

- high-quality nylon 6, impact resistant, hardness 70 Shore D, extremely robust heavy-duty version, colour natural white

Additional details:

- bracket series: page 94
- brakes: page 112–113
- wheel series: page 355–356
- bearing types: page 84–85

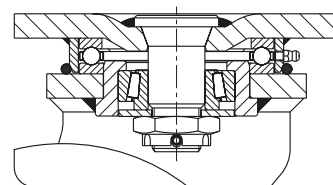
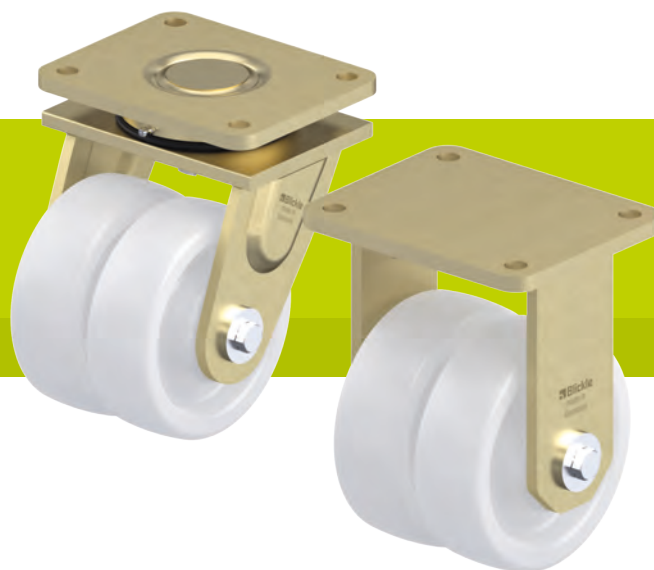

Swivel castors	Fixed castors	Wheel Ø [mm]	Wheel width [mm]	Load capacity [kg]	Bearing type	Total height [mm]	Plate size [mm]	Bolt hole spacing [mm]	Bolt hole Ø [mm]	Offset swivel castor [mm]
LSD-SPO 127K	BSD-SPO 127K	125	2 x 50	1,350	ball bearing	185	175 x 140	140 x 105	14	50
LSD-SPO 150K-35	BSD-SPO 150K-35	150	2 x 50	1,450	ball bearing	215	175 x 140	140 x 105	14	55
LSD-SPO 160K-35	BSD-SPO 160K-35	160	2 x 50	1,550	ball bearing	220	175 x 140	140 x 105	14	55
LSD-SPO 200K-35	BSD-SPO 200K-35	200	2 x 50	2,700	ball bearing	260	175 x 140	140 x 105	14	60
LSD-SPO 250K	BSD-SPO 250K	250	2 x 65	3,600	ball bearing	330	255 x 200	210 x 160	18	70

Fixed castors: long side of plate parallel to the wheel axle

Versions / options



	with "Radstop" wheel brake	with "Radstop" wheel brake	with directional lock 4 x 90°	with directional lock 4 x 90° (inserted by hand)	with steel foot guard
Technical description page	113	113	115	115	116
Product code suffix	-RA	-RAH	-RI4	-RI4H	-FS
Available for	up to wheel Ø 200 mm upon request	wheel Ø 250 mm upon request	up to wheel Ø 200 mm upon request	wheel Ø 250 mm upon request	upon request

GSPO series

Heavy-duty cast nylon wheels

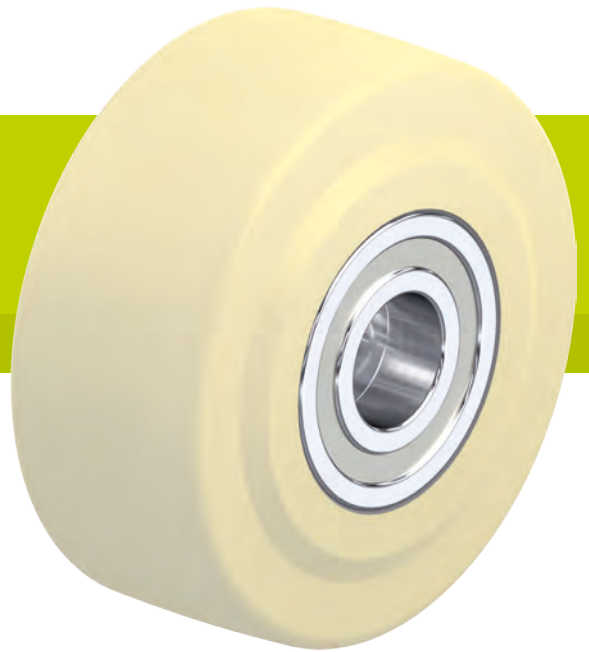

100–50,000 kg

Tread and tyre hardness
 80 Shore D

Smooth operation / floor preservation
 satisfactory

Rolling resistance
 excellent

Wear resistance
 very good

- Wheel:**
- high-quality cast nylon, reaction-injected, impact resistant, hardness 80 Shore D
 - extremely high load capacity
 - excellent rolling and swivel resistance
 - easy operation on smooth surfaces
 - high abrasion resistance
 - colour natural beige

- Other features:**
- high chemical resistance to many aggressive substances
 - reduced moisture absorption
 - operating temperature: -20 °C to +80 °C, reduced load capacity over +35 °C
 - consider the surface pressure on sensitive floors due to high point loads

- Additional details:**
- wheel series: page 70
 - tread: page 57
 - bearing types: page 84–85
 - chemical resistance: page 51

Wheels	Wheel Ø (D) [mm]	Wheel width (T2) [mm]	Load capacity [kg]	Bearing type	Axle bore Ø (d) [mm]	Hub length (T1) [mm]
GSPO 35/8K	35	28	100 *	ball bearing	8	28
GSPO 50/15K	50	32	250 *	ball bearing	15	35
GSPO 60/15K	60	32	350 *	ball bearing	15	35
GSPO 65/15K	65	40	650 *	ball bearing	15	45
GSPO 80/20K	80	40	1,000 *	ball bearing	20	45
GSPO 100/20K	100	40	1,250 *	ball bearing	20	45
GSPO 101/25K	100	55	1,500 *	ball bearing	25	60
GSPO 125/25K	125	55	2,000 *	ball bearing	25	60
GSPO 150/30K	150	55	2,500 *	ball bearing	30	60
GSPO 152/35K	150	80	3,000 *	ball bearing	35	90
GSPO 200/35K	200	55	3,000 *	ball bearing	35	60
GSPO 202/45K	200	80	4,500 *	ball bearing	45	90
GSPO 250/45K	250	65	5,000 *	ball bearing	45	70
GSPO 252/50K	250	80	6,000 *	ball bearing	50	90
GSPO 300/55K	300	80	7,000 *	ball bearing	55	90
GSPO 302/70K	300	110	10,000 *	ball bearing	70	120
GSPO 400/80K	400	110	12,000 *	ball bearing	80	120
GSPO 500/100K	500	130	18,000 *	ball bearing	100	130
GSPO 600/100PR	600	150	22,000 *	spherical roller bearing	100	170
GSPO 700/130PR	700	200	30,000 *	spherical roller bearing	130	220
GSPO 1000/160PR	1,000	250	50,000 *	spherical roller bearing	160	280

* Load capacity test in compliance with DIN 12532 with extended breaks to avoid thermal overloading
Other dimensions available upon request

Versions / options

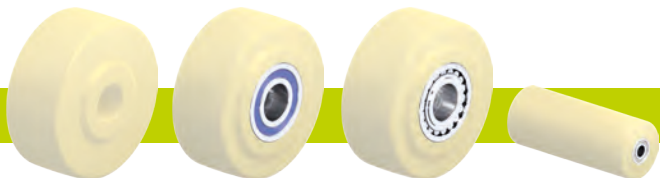

	plain bore version	with stainless steel ball bearing in the wheel hub	with spherical roller bearing	other versions
Technical description page	84	84	85	
Product code suffix		-XK	-PR	
Available for	upon request	upon request**	upon request	upon request

** Some dimensions may result in reduced load capacities

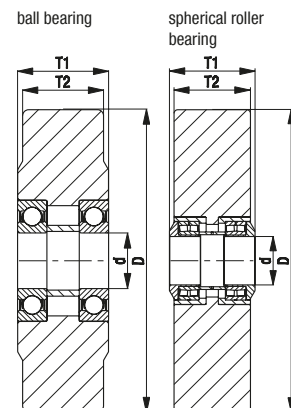

LH-GSPO, BH-GSPO series

Pressed steel castors, heavy-duty design, with top plate, with heavy-duty wheel made of cast nylon



650–900 kg

Bracket: LH/BH series

- strong pressed steel, zinc-plated, blue-passivated, Cr6-free
- heavy fork and top plate

Swivel bracket:

- double ball bearing in the swivel head
- bolted and secured central kingpin, extremely strong
- particularly resistant to shocks and impact due to **four specially-shaped, hardened bearing seats**

Wheel: GSPO series

- high-quality cast nylon, reaction-injected, impact resistant, hardness 80 Shore D, colour natural beige

Additional details:

- bracket series: page 92
- brakes: page 112–113
- wheel series: page 368
- bearing types: page 84–85

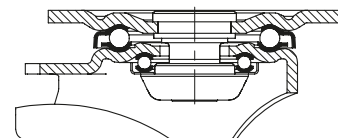

Swivel castors	Fixed castors	Swivel castors with "stop-fix" brake	Wheel Ø [mm]	Wheel width [mm]	Load capacity [kg]	Bearing type	Total height [mm]	Plate size [mm]	Bolt hole spacing [mm]	Bolt hole Ø [mm]	Offset swivel castor [mm]
LH-GSPO 65K	BH-GSPO 65K		65	40	650 *	ball bearing	97	100 x 85	80 x 60	9	45
LH-GSPO 80K	BH-GSPO 80K	LH-GSPO 80K-FI	80	40	700 *	ball bearing	120	100 x 85	80 x 60	9	45
LH-GSPO 100K-1	BH-GSPO 100K-1	LH-GSPO 100K-1-FI	100	40	700	ball bearing	140	100 x 85	80 x 60	9	45
LH-GSPO 100K-3	BH-GSPO 100K-3	LH-GSPO 100K-3-FI	100	40	700	ball bearing	140	140 x 110	105 x 75–80	11	45
LH-GSPO 125K	BH-GSPO 125K	LH-GSPO 125K-FI	125	55	900	ball bearing	170	140 x 110	105 x 75–80	11	55

*Load capacity test in compliance with DIN 12530 with extended breaks to avoid thermal overloading

Versions / options



	with "stop-top" brake	directional lock (separate) 1 x 360°	directional lock (separate) 1 x 360°	directional lock (separate) 1 x 360°	with steel foot guard	with stainless steel ball bearing in the wheel hub
Technical description page	112	115	115	115	116	84
Product code suffix	-ST	RI-04.01	RI-04.03	RI-05.03	-FS	-XK
Available for	wheel Ø 80–125 mm	wheel Ø 80–100 mm with plate 100x85 mm**	wheel Ø 100 mm with plate 140x110 mm**	wheel Ø 125 mm**	wheel Ø 80–125 mm	upon request***

** Only for swivel castors without brake or swivel castor with "stop-top" brake upon request

*** Some dimensions may result in reduced load capacities

LS-GSPO, BS-GSPO series

Welded steel heavy-duty castors, extra heavy-duty swivel head, with heavy-duty wheel made of cast nylon

1,500–12,000 kg

Bracket: LS/BS series

- particularly robust welded steel construction, zinc-plated, yellow-passivated, Cr6-free

Swivel bracket:

- axial grooved ball bearing ISO 104 and tapered roller bearing ISO 355 in the swivel head
- bolted and secured welded central kingpin, extremely strong
- dust and splash-proof
- grease nipple

Wheel: GSPO series

- high-quality cast nylon, reaction-injected, impact resistant, hardness 80 Shore D, colour natural beige

Additional details:

- bracket series: page 94
- brakes: page 112–113
- wheel series: page 368
- bearing types: page 84–85

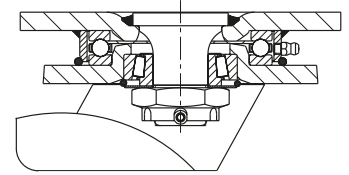
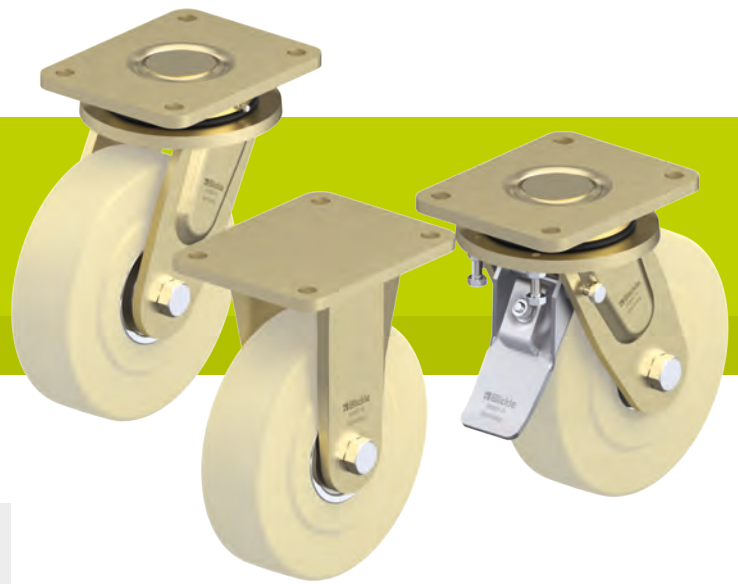

6

Swivel castors	Fixed castors	Swivel castor with "stop-top" brake	Wheel Ø [mm]	Wheel width [mm]	Load capacity [kg]	Bearing type	Total height [mm]	Plate size [mm]	Bolt hole spacing [mm]	Bolt hole Ø [mm]	Offset swivel castor [mm]
LS-GSPO 101K	BS-GSPO 101K	LS-GSPO 101K-ST	100	55	1,500 *	ball bearing	145	140 x 110	105 x 75–80	11	50
LS-GSPO 125K	BS-GSPO 125K	LS-GSPO 125K-ST	125	55	1,750 *	ball bearing	170	140 x 110	105 x 75–80	11	50
LS-GSPO 150K-35	BS-GSPO 150K-35	LS-GSPO 150K-35-ST	150	55	2,500	ball bearing	205	175 x 140	140 x 105	14	65
LS-GSPO 152K-35	BS-GSPO 152K-35	LS-GSPO 152K-35-ST	150	80	3,000 *	ball bearing	205	175 x 140	140 x 105	14	65
LS-GSPO 200K-35	BS-GSPO 200K-35	LS-GSPO 200K-35-ST	200	55	3,000	ball bearing	255	175 x 140	140 x 105	14	65
LS-GSPO 202K	BS-GSPO 202K	**	200	80	4,500 *	ball bearing	280	255 x 200	210 x 160	18	75
LS-GSPO 250K	BS-GSPO 250K	**	250	65	5,000	ball bearing	330	255 x 200	210 x 160	18	80
LS-GSPO 252K	BS-GSPO 252K	**	250	80	6,000	ball bearing	330	255 x 200	210 x 160	18	80
LS-GSPO 300K	BS-GSPO 300K	**	300	80	6,000	ball bearing	380	255 x 200	210 x 160	18	90
LS-GSPO 302K	BS-GSPO 302K	**	300	110	10,000	ball bearing	430	400 x 300	340 x 240	26	110
LS-GSPO 400K	BS-GSPO 400K	**	400	110	12,000	ball bearing	530	400 x 300	340 x 240	26	125

* Load capacity test in compliance with DIN 12532 with extended breaks to avoid thermal overloading

** "Radstop" brake version

Versions / options



	with "Radstop" wheel brake	with directional lock 4 x 90°	with directional lock 4 x 90° (inserted by hand)	with steel foot guard	with stainless steel ball bearing in the wheel hub
Technical description page	113	115	115	116	84
Product code suffix	-RAH	-RI4	-RI4H	-FS	-XK
Available for	from wheel Ø 200x80 mm upon request	wheel Ø 100–200x55 mm	wheel Ø 200x80–400 mm upon request	wheel Ø 100–200 mm	upon request***

*** Some dimensions may result in reduced load capacities

LSD-GSP0, BSD-GSP0, LSSD-GSP0, BSSD-GSP0 series

Welded steel extra heavy-duty twin wheel castors, extra heavy-duty swivel head, with heavy-duty wheels made of cast nylon

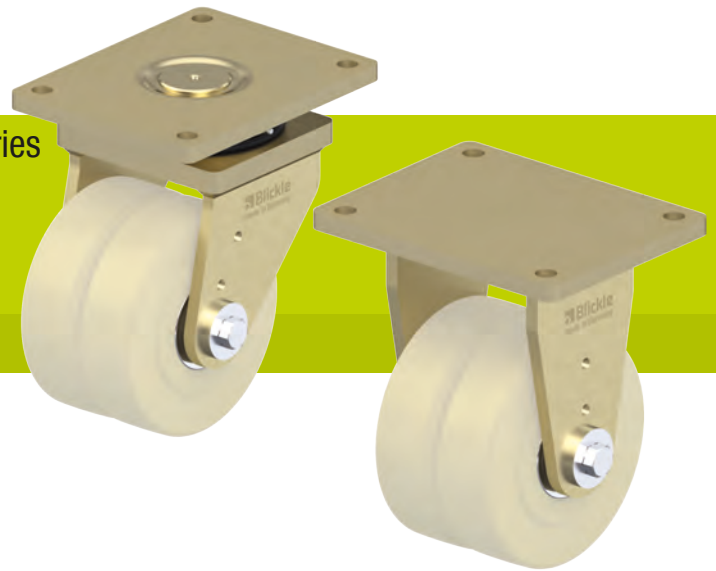

1,750–30,000 kg

Bracket: LSD/BSL, LSSD/BSSD series

- particularly robust welded steel construction, zinc-plated, yellow-passivated, Cr6-free

Swivel bracket:

- axial grooved ball bearing ISO 104 and tapered roller bearing ISO 355 in the swivel head
- LSSD-GSP0 500K: four-point swivel bearing for extremely heavy loads
- bolted and secured welded central kingpin, extremely strong (with exception of LSSD-GSP0 500K)
- dust and splash-proof
- grease nipple

Wheel: GSP0 series

- high-quality cast nylon, reaction-injected, impact resistant, hardness 80 Shore D, colour natural beige

Additional details:

- bracket series: page 94
- brakes: page 112–113
- wheel series: page 368
- bearing types: page 84–85

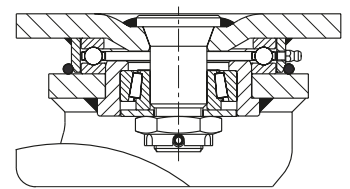

Swivel castors	Fixed castors	Wheel Ø [mm]	Wheel width [mm]	Load capacity [kg]	Bearing type	Total height [mm]	Plate size [mm]	Bolt hole spacing [mm]	Bolt hole Ø [mm]	Offset swivel castor [mm]
LSD-GSP0 80K	BSD-GSP0 80K	80	2 x 40	1,750 *	ball bearing	125	140 x 110	105 x 75–80	11	40
LSD-GSP0 100K	BSD-GSP0 100K	100	2 x 40	2,250 *	ball bearing	160	175 x 140	140 x 105	14	45
LSD-GSP0 125K	BSD-GSP0 125K	125	2 x 55	3,600 *	ball bearing	205	255 x 200	210 x 160	18	50
LSD-GSP0 150K	BSD-GSP0 150K	150	2 x 55	4,500	ball bearing	230	255 x 200	210 x 160	18	55
LSD-GSP0 200K	BSD-GSP0 200K	200	2 x 55	5,400	ball bearing	290	255 x 200	210 x 160	18	60
LSD-GSP0 250K	BSD-GSP0 250K	250	2 x 65	9,000	ball bearing	380	400 x 300	340 x 240	26	110
LSD-GSP0 302K	BSD-GSP0 302K	300	2 x 110	18,000	ball bearing	500	500 x 400	400 x 300	33	110
LSD-GSP0 400K	BSD-GSP0 400K	400	2 x 110	20,000	ball bearing	600	500 x 400	400 x 300	33	125
LSSD-GSP0 500K	BSSD-GSP0 500K	500	2 x 130	30,000	ball bearing	675	500 x 500	400 x 400	39	150

* Load capacity test in compliance with DIN 12532 with extended breaks to avoid thermal overloading
Fixed castors: long side of plate parallel to the wheel axle

Versions / options



	image LSSD-GSP0 500K	with "Radstop" wheel brake	with directional lock 4 x 90°	with directional lock 4 x 90° (inserted by hand)	with steel foot guard
Technical description page		113	115	115	116
Product code suffix		-RAH	-RI4	-RI4H	-FS
Available for		upon request	wheel Ø 80–100 mm upon request	wheel Ø 125–500 mm upon request	upon request